



Sehr geehrte Kunden,

dieser Katalog stellt die allgemeinen Ersatzteile für Europäische LKWs dar. Alle gezeigten Artikel in diesem Katalog sind austauschbar mit den Originalteilen, sind aber nicht Original. Die ursprünglichen Nummern sind nur zu Ihrer Information erwähnt.

Jedoch sind alle hierin beinhaltenen Beschreibungen und andere Anmerkungen Änderungen vorbehalten. Und wir übernehmen für Fehler in dieser Ausgabe keine Haftung.

Dear customer,

This catalogue represents general replacement parts for European trucks. All illustrated items in this catalogue are replaceable to the original ones, are not original. The original numbers has been mentioned for your information only.

However all descriptions and other remarks contained herein are subject to change without further notice. And we have no liability for any errors in this issue.

Cher clients

Ce catalogue représente les pièces de remplacement pour la plupart des camions européens. Tous les articles illustrés remplacent les originaux et ne sont pas originaux, les nombres originaux ont été mentionnés seulement pour votre Information.

Cependant toutes les descriptions et d'autres remarques contenues ci-dessus sont sujettes au changement sans préavis et nous n'avons aucune responsabilité pour erreurs dans cette issue.



# Certificate of Registration



This is to certify that the quality management system of

## KTK Germany GmbH

Head Office: Auf dem Brahm, 99, 42281, Wuppertal, Dusseldorf East, Germany

has been assessed and registered by Intertek as conforming to the requirements of:

### ISO 9001:2008

The quality management system is applicable to  
*Trading of Spare Parts for the Automotive Industry.*

Certificate Number: QMS 18332-01  
Certificate Issue Date: 27 April 2017  
Certificate Expiry Date: 14 September 2018

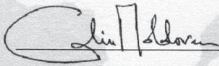

*Authorised Signature: Calin Moldovean – President, Business Assurance  
Intertek Certification Limited, 10A Victory Park, Victory Road, Derby DE24 8ZF*

Intertek Certification Limited is a UKAS accredited body under schedule of accreditation no. 014.

In the issuance of this certificate, Intertek assumes no liability to any party other than to the Client, and then only in accordance with the agreed upon Certification Agreement. This certificate's validity is subject to the organisation maintaining their system in accordance with Intertek's requirements for systems certification. Validity may be confirmed via email at [certificate.validation@intertek.com](mailto:certificate.validation@intertek.com) or by scanning the code to the right with a smartphone.

The certificate remains the property of Intertek, to whom it must be returned upon request.

CT-ISO 9001:2008-UKAS-EN-A4-P-20.jun.13



014





## MERCEDES

KTK	RF: No.	Page	KTK	RF: No.	Page
06467	442 187 0080	GR 14 01/01	06644	652 420 0038	GR 42 02/02
06468	326 997 0149	GR 20 01/02	06645	652 420 0238	GR 42 02/02
06469	917 003 026 003	GR 18 03/02	06710	402 130 0220	GR 13 01/03
06470	352 078 0180	GR 07 01/03	06738		GR 26 06/07
06471	422 142 0080cpl	GR 14 01/02	06739	389 261 1280	GR 26 06/08
06472	422 144 0280	GR 14 01/01	06740	389 268 2080	GR 26 06/08
06473	422 142 0080	GR 14 01/01	06741	389 268 2180	GR 26 06/08
06474		GR 26 06/04	06742	389 268 1180	GR 26 06/08
06475	000 268 6080	GR 26 06/05	06743	389 268 1480	GR 26 06/08
06476	000 264 9980	GR 26 06/05	06744	387 261 4280	GR 26 06/09
06477	000 264 7680	GR 26 06/05	06863	346 016 0320	GR 01 03/05
06479	442 016 0121	GR 01 03/01	06888	389 261 1480	GR 26 06/09
06480	355 142 0180 Cpl.	GR 14 01/03	06927	442 131 0780	GR 13 01/03
06481	427 144 0180	GR 14 01/02	06928	442 131 0980	GR 13 01/03
06482	346 017 0160	GR 01 03/02	06929	346 015 0120	GR 01 06/02
06483	442 141 0480	GR 01 03/02	06930	000 262 2380	GR 26 06/03
06484	350 492 0080 CPL	GR 49 01/01	06930	000 262 2380	GR 26 06/05
06485	302 490 0080 CPL	GR 49 01/01	06931	352 586 1290	GR 01 03/07
06486	000 260 1668	GR 26 06/06	06932	366 016 0620	GR 01 03/05
06487	000 262 2480	GR 26 06/06	06933	352 010 0580	GR 01 03/06
06488	423 010 4833	GR 01 06/01	06934	352 016 0921	GR 01 03/06
06489	442 188 0580	GR 18 03/01	06935	352 142 0480	GR 01 07/01
06490	541 011 0080	GR 01 05/01	06936	423 016 0420	GR 01 03/01
06491	355 016 0021	GR 01 03/06	06937		GR 07 01/03
06492	403 142 0380	GR 01 03/01	06938	442 011 0059	GR 01 05/01
06493	441 014 0022	GR 01 01/01	06939	343 261 0752	GR 26 06/01
06494	355 010 0280	GR 01 01/01	06940	343 263 0062	GR 26 02/02
06495	442 131 0080	GR 13 01/03	06942	000 429 2184	GR 99 03/03
06496	346 142 0060	GR 01 07/01	06943	000 997 5348	GR 18 03/03
06497	355 142 0280	GR 01 07/01	06944		GR 26 06/07
06498	442 184 0580	GR 18 03/01	06945	441 130 0220	GR 13 01/05
06499	355 184 0480	GR 18 03/01	07157		GR 99 08/01
06500	355 203 0080	GR 20 01/01	07158		GR 99 08/02
06501		GR 26 06/01	07159		GR 99 08/02
06508	442 014 0222	GR 01 01/01	07224	403 053 0052	GR 05 03/01
06509	355 142 0180	GR 14 01/02	07225	403 053 0152	GR 05 03/01
06510	442 131 2280	GR 13 01/05	07228	364 010 0180	GR 01 03/06
06511	007 603 010 103	GR 99 05/05	07229	314 010 0280	GR 01 03/06
06512	007 306 012 110	GR 99 05/05	07230	364 016 0720	GR 01 03/05
06513	007 603 014 106	GR 99 05/06	07285		GR 99 06/01
06514	007 603 016 103	GR 99 05/06	07286		GR 99 06/01
06516	002 990 9901 CPL	GR 35 06/01	07287		GR 99 06/01
06517	002 990 8201 CPL	GR 35 06/01	07288		GR 99 06/01
06518	002 990 8401 CPL	GR 35 06/01	07289		GR 99 06/01
06526	346 420 1738	GR 42 02/01	07290		GR 99 06/02
06527	346 420 1838	GR 42 02/01	07291		GR 99 06/02
06551	617 420 0238	GR 42 02/02	07292		GR 99 06/02
06554	303 993 0410	GR 42 06/01	07293		GR 99 06/02
06555	403 993 0810	GR 09 05/01	07294		GR 99 06/03
06561	346 993 0210	GR 42 06/01	07295		GR 99 06/03
06562	346 993 0310	GR 42 06/01	07296		GR 99 06/03
06563	352 993 1910	GR 09 05/01	07297		GR 99 06/03
06642	617 420 0338	GR 42 02/01	07298		GR 99 06/03
06643	617 420 0438	GR 42 02/01	07299		GR 99 06/04
			07300		GR 99 06/04

## MERCEDES

KTK	RF: No.	Page	KTK	RF: No.	Page
07301		GR 99 06/04	07622	000 090 8850	GR 09 01/05
07302		GR 99 06/04	07625	000 091 0910	GR 09 01/01
07321	002 431 1506	GR 43 01/07	07627	000 091 0319	GR 09 01/01
07322	001 431 3406	GR 43 01/07	07628	000 091 0840	GR 09 01/02
07324	001 431 8305	GR 43 01/02	07629	000 091 0039	GR 09 01/02
07326	001 431 8706	GR 43 01/05	07630	000 993 0005	GR 09 01/02
07327	001 431 0106	GR 43 01/05	07631	000 997 0040	GR 09 01/03
07328	001 431 0512	GR 43 01/04	07632	000 091 0040	GR 09 01/03
07329	001 431 8112	GR 43 01/04	07633	000 091 0541	GR 09 01/03
07331	001 431 1805	GR 43 01/06	07634		GR 09 01/03
07332	001 431 6705	GR 43 01/06	07635	000 477 0002	GR 09 01/03
07333	000 429 6544	GR 42 07/02	07636	442 074 0059	GR 07 01/02
07334	001 429 6844	GR 42 07/02	07637	442 993 5110	GR 09 05/01
07335		GR 43 01/08	07638	000 077 0325	GR 07 01/03
07336	001 430 0981	GR 43 01/05	07639	000 477 3580	GR 09 01/04
07337	002 430 7681	GR 43 01/05	07640	422 090 0252	GR 09 01/04
07338	000 429 4144	GR 42 07/02	07641	000 477 3508	GR 09 01/04
07339	000 434 0601	GR 43 01/03	07642	360 077 0180	GR 07 01/02
07396	000 262 1880	GR 26 06/01	07643	447 187 0080	GR 14 01/02
07407	403 053 1122	GR 05 01/01	07644	407 187 0180	GR 14 01/02
07408	000 090 0210	GR 09 01/01	07648	403 053 0331	GR 05 02/02
07409	000 090 0151	GR 09 01/02	07649	387 262 0893	GR 26 06/11
07410	001 997 0772	GR 99 01/01	07650	387 262 1093	GR 26 06/11
07411	107 991 0041	GR 01 02/02	07651	442 187 0180	GR 14 01/01
07446	442 131 0180	GR 13 01/06	07652	355 030 2820	GR 03 01/01
07447		GR 13 01/01	07653	422 030 0420	GR 03 01/01
07522	363 891 0717	GR 31 01/02	07655	000 090 0610	GR 09 01/02
07523	620 528 0782	GR 09 04/01	07656	361 528 0091	GR 09 04/01
07524	620 268 0196	GR 26 02/02	07657	897 670 1904	GR 13 01/02
07525	403 155 0250	GR 15 02/02	07658	897 670 9004	GR 13 01/02
07526	442 015 0060	GR 01 06/02	07659	000 131 3831	GR 13 01/02
07527	403 015 0160	GR 01 06/01	07660	009 997 7246	GR 13 01/01
07528	363 891 0223	GR 31 01/02	07661	000 131 4631	GR 13 01/02
07529	000 094 7980	GR 09 01/08	07662	001 131 7280	GR 13 01/01
07530	000 094 2580	GR 09 01/07	07663	000 131 2079	GR 13 01/01
07531	201 292 0082	GR 29 01/01	07664	000 131 2179	GR 13 01/01
07533	403 074 0059	GR 07 01/02	07665		GR 13 01/07
07534	000 477 3180	GR 09 01/04	07666	442 030 0220	GR 03 01/01
07536	008 997 6145	GR 07 01/02	07668		GR 13 01/06
07537	008 997 7045	GR 18 03/01	07669	355 180 1265	GR 18 01/01
07539		GR 99 03/04	07670	001 188 3101	GR 18 01/01
07595	403 016 0061	GR 01 03/02	07671	002 188 4301	GR 18 01/01
07596	422 053 0196	GR 01 03/02	07672	001 188 8901	GR 18 01/01
07597	423 010 0220	GR 01 03/01	07673	000 184 6580	GR 18 03/01
07598	356 015 0121	GR 01 06/02	07674	003 203 7975	GR 20 02/01
07599	443 014 0022	GR 01 01/01	07675		GR 20 02/01
07600	355 053 1131	GR 05 02/01	07676	003 997 5748	GR 20 02/01
07601	355 053 1832	GR 05 02/01	07677	000 960 018 148	GR 24 01/02
07602	352 053 0296	GR 05 03/01	07678	620 260 0040	GR 26 01/01
07604	355 053 0131	GR 05 02/01	07680	620 268 0157	GR 26 01/01
07605	355 053 0032	GR 05 02/01	07681	620 268 0097	GR 26 02/01
07608	352 053 0320	GR 05 01/01	07687	000 260 2868	GR 26 06/04
07609	403 053 0120	GR 05 01/01	07688	000 586 0526	GR 26 06/02
07610	326 054 0605	GR 05 05/01	07689	389 262 0293	GR 26 06/11
07611	326 054 0705	GR 05 05/01	07690	387 310 0077	GR 31 01/01
07612	422 054 0105	GR 05 05/01	07691	387 586 0531	GR 31 01/01
07613	346 054 0201	GR 05 04/01	07692	381 586 0031	GR 31 01/01
07614	403 054 1801	GR 05 04/01	07701	385 351 0172	GR 35 03/01
07615	001 091 2501	GR 09 01/06	07702	385 351 0672	GR 35 03/01
07616	000 090 0650	GR 09 01/06			
07617	000 090 3150	GR 09 01/06			
07618	000 091 1280	GR 09 01/01			
07619	000 091 1101	GR 09 01/05			
07620	000 074 0515	GR 07 01/01			
07621	000 477 0329	GR 07 01/01			

## MERCEDES

KTK	RF: No.	Page	KTK	RF: No.	Page
07703	346 353 0072	GR 35 03/01	07776	915 062 004 000	GR 99 05/04
07704	385 351 0572	GR 35 03/01	07777	915 062 006 000	GR 99 05/04
07705	346 356 0315	GR 35 04/01	07778	915 062 008 000	GR 99 05/04
07715	355 356 0915	GR 35 04/03	07779	915 062 009 000	GR 99 05/04
07716	355 356 0126	GR 35 04/03	07780	915 062 012 000	GR 99 05/05
07717	395 320 0265	GR 32 01/02	07781		GR 99 05/01
07718	389 320 0065	GR 32 01/01	07782		GR 99 05/01
07719	391 330 0019	GR 33 02/01	07783		GR 99 05/01
07720	000 262 2580	GR 26 06/04	07784		GR 99 05/01
07721	000 268 6180	GR 26 06/02	07785		GR 99 05/01
07722	000 268 5880	GR 26 06/02	07786		GR 99 05/02
07723	000 268 5180	GR 26 06/03	07929	355 350 0128	GR 35 05/03
07724	000 268 6380	GR 26 06/03	07930	442 053 0032	GR 05 02/02
07725	000 268 6280	GR 26 06/03	07931	000 912 012 047	GR 35 03/01
07726	000 268 5780	GR 26 06/05	07932	000 933 012 069	GR 26 02/02
07727	001 264 0380	GR 26 06/02	07933	000 960 016 249	GR 24 01/02
07728	000 268 5980	GR 26 06/06	07958	422 053 0531	GR 05 02/02
07732		GR 26 06/04	07964		GR 01 07/01
07733	338 413 0012	GR 41 02/02	07970	305 421 0401	GR 42 08/01
07734	363 413 0012	GR 41 02/01	07971	305 423 0401	GR 42 08/01
07737	395 420 0082	GR 42 01/01	07972	346 423 0501	GR 42 08/01
07739	346 994 0109	GR 42 01/01	07973	346 423 0601	GR 42 08/02
07740	307 421 0550	GR 42 01/01	08000	000 268 1280	GR 26 06/01
07741		GR 42 04/01	08012	447 990 5204	GR 14 02/01
07742	000 431 1728	GR 42 04/01	08116	403 201 1080	GR 20 01/02
07743	000 421 2986	GR 42 04/01	08117	356 201 0180	GR 20 01/01
07744	000 431 0728	GR 42 04/01	08178	363 475 0220	GR 09 04/02
07745	000 421 2086	GR 42 04/01	08179	360 997 0982	GR 46 02/01
07746	000 423 1286	GR 42 04/02	08180	343 997 0582	GR 46 02/01
07747		GR 42 04/02	08218		GR 99 07/01
07748	000 431 2028	GR 42 05/01	08219		GR 99 07/01
07749	000 421 4286	GR 42 05/01	08235		GR 99 07/01
07750	000 423 3486	GR 42 05/01	08251	000 420 7424	GR 42 11/01
07751	000 421 6286	GR 42 05/01	08252	000 420 8024	GR 42 11/01
07753	302 490 0080	GR 49 01/01	08253		GR 43 01/07
07754	350 492 0080	GR 49 01/01	08273	915 011 008 103	GR 99 01/02
07755	347 504 0012	GR 50 01/01	08274	915 011 010 102	GR 99 01/02
07756	336 504 0012	GR 50 01/01	08275	915 047 010 100	GR 99 01/02
07757	387 504 0012	GR 50 01/01	08276	915 047 012 100	GR 99 01/02
07758	620 504 0112	GR 50 01/02	08277	000 074 1771	GR 09 01/04
07759	338 500 0045	GR 50 01/01	08285		GR 13 01/07
07763	338 500 0045 CPL	GR 50 01/01	08286		GR 13 01/07
07764	007 603 008 109	GR 99 05/05	08366	000 090 0050	GR 09 01/05
07765	007 603 006 106	GR 99 05/05	08367	000 091 1101S	GR 09 01/05
07766	003 870 006 105	GR 99 05/02	08375		GR 99 08/02
07767	003 870 008 102	GR 99 05/02	08376		GR 99 08/02
07768	003 870 010 103	GR 99 05/02	08377		GR 99 08/01
07769	003 870 012 104	GR 99 05/02	08378		GR 99 08/01
07770	003 870 015 101	GR 99 05/03	08419	201 291 0282	GR 29 01/01
07771	003 861 006 006	GR 99 05/03	08456	621 490 0065	GR 49 02/02
07772	003 861 008 004	GR 99 05/03	08457	620 490 0365	GR 49 02/01
07773	003 861 010 006	GR 99 05/03	08458	620 490 0465	GR 49 02/01
07774	003 861 012 006	GR 99 05/03	08459	309 673 0031	GR 67 01/01
07775	003 861 015 004	GR 99 05/04	08460	673 697 0098	GR 67 01/01
			08461	381 300 1730	GR 30 01/01
			08462	620 300 0130	GR 30 01/01

## MERCEDES

KTK	RF: No.	Page	KTK	RF: No.	Page
08463	381 300 1430	GR 30 01/01	08869	000 429 3930	GR 99 03/02
08464	000 350 0413	GR 35 02/01	08870	000 429 4030	GR 99 03/02
08465	000 350 0613	GR 35 02/01	08871	000 429 3430	GR 99 03/03
08466	000 350 0213	GR 35 01/01	08872	000 429 2184	GR 99 03/03
08467	000 586 1533	GR 35 01/01	08873	000 429 3530	GR 99 03/02
08469	389 881 0298	GR 67 01/01	08874	000 429 3630	GR 99 03/02
08478	541 016 0920	GR 01 03/04	08880	000 268 6289	GR 26 07/01
08479	541 016 0321	GR 01 03/04	08881	000 268 6189	GR 26 07/01
08480	541 142 0180	GR 01 03/04	08882	000 268 4889	GR 26 07/01
08481	541 098 0480	GR 01 03/04	08883	302 330 0235	GR 33 01/01
08482	541 014 0322	GR 01 01/01	08884	001 330 0135	GR 33 01/01
08483	541 010 1120	GR 01 03/03	08885	346 460 0105	GR 46 04/01
08499		GR 13 01/04	08886	346 460 1505	GR 46 04/01
			08887	001 460 2248	GR 46 04/01
			08888	001 460 2348	GR 46 04/01
			08889	387 460 3305	GR 46 04/01
08500	001 131 1511	GR 13 01/05	08890	620 460 3705	GR 46 04/02
08518	001 295 3107	GR 29 03/01	08899	389 410 0122	GR 41 02/01
08525	000 290 3267	GR 29 03/01	08900	395 410 0622	GR 41 02/01
08546	623 423 0136	GR 42 03/01	08903	385 586 0141	GR 41 02/01
08547	623 423 0236	GR 42 03/01	08905	000 545 6909	GR 54 04/01
08562	441 030 0820	GR 03 01/01	08906	003 545 1614	GR 54 04/01
08620	000 091 2190	GR 09 01/05	08907	000 545 7909	GR 54 04/02
08640		GR 13 01/02	08908	000 545 7009	GR 54 04/01
08641		GR 13 01/03	08913	000 545 8114	GR 54 04/01
08642	442 131 0780	GR 13 01/04	08914	001 545 1309	GR 54 04/02
08643		GR 13 01/05	08915	001 545 1209	GR 54 04/02
08647	652 420 0138	GR 42 02/02	08916	000 545 4909	GR 54 04/01
08652	355 010 0220	GR 01 02/01	08918	442 031 0027	GR 03 04/01
08653	422 010 0020	GR 01 02/01	08919	403 032 0309	GR 03 04/01
08654	355 010 0620	GR 01 02/01	08920	650 254 0474	GR 25 01/01
08665	001 981 7605	GR 35 07/01	08921	655 250 0069	GR 25 01/01
08666	004 981 9805	GR 35 07/01	08936	000 430 1107	GR 43 01/07
08667	003 981 6805	GR 35 07/01	08937	001 430 4960	GR 43 01/08
08786	641 720 0246	GR 72 01/03	08938	001 430 0460	GR 43 01/02
08787	641 720 0346	GR 72 01/03	08940	000 430 3006	GR 43 01/02
08788	381 725 0002	GR 72 01/01	08941		GR 43 01/02
08789	381 725 0102	GR 72 01/01	08942		GR 43 01/06
08790	322 725 0202	GR 72 01/01	08943	002 430 1860	GR 43 01/07
08791	322 725 0302	GR 72 01/01	08948	000 430 7560	GR 43 01/04
08796	422 016 0620	GR 01 03/03	08949		GR 43 01/14
08797	444 010 0120	GR 01 03/03	08950	000 290 0347	GR 29 03/01
08798	423 010 0320	GR 01 03/01	08952		GR 29 03/02
08816	447 990 7104	GR 14 02/01	08953	000 430 4960	GR 43 01/05
08817	447 990 5404	GR 14 02/01	08968	014 997 4647	GR 01 08/01
08818	385 400 0124	GR 40 01/02	08974	006 420 1118	GR 42 11/01
08854	335 997 2282	GR 99 04/01	08979		GR 26 06/07
08855	008 997 6082	GR 99 04/01	08980		GR 26 06/01
08856	008 997 9082	GR 99 04/01	08981		GR 26 06/06
08857	001 997 0652	GR 99 04/01	08982		GR 26 06/04
08858	008 997 5482	GR 99 04/01	08983		GR 26 06/09
08859	010 997 5982	GR 99 04/02	08984	000 267 0697	GR 26 06/07
08860	010 997 4682	GR 99 04/02	08985		GR 26 06/07
08861		GR 99 03/01	08986		GR 13 01/04
08862		GR 99 03/01	09003	442 053 0531	GR 05 02/03
08863		GR 99 03/01	09004		GR 05 02/01
08864		GR 99 03/01	09005		GR 05 02/02
08865		GR 99 03/01	09006		GR 05 02/02
08866		GR 99 03/02	09007		GR 05 02/03
08867	000 429 7630	GR 99 03/03	09008		GR 05 02/03
08868	000 429 3830	GR 99 03/03	09010	403 142 0212	GR 14 01/03
			09015	624 421 0201	GR 42 08/02
			09026		GR 20 02/01
			09038	442 141 0980	GR 14 01/01
			09046	001 980 2702	GR 35 07/01
			09059	000 053 5358	GR 01 03/04



## MERCEDES

KTK	RF: No.	Page	KTK	RF: No.	Page
09060		GR 01 03/03	09946	641 760 0359	GR 76 01/01
09061	442 016 0621	GR 01 03/03	10016	366 015 0020	GR 01 06/02
09082	383 324 0008	GR 32 01/01	10058	020 997 3947	GR 35 05/03
09083	343 586 0032	GR 35 01/01	10059	005 997 1945	GR 13 01/08
09110	074 361 022 205	GR 40 01/01	10071	000 434 2301	GR 43 01/03
09111	389 401 0071 cpl	GR 40 01/01	10072	006 997 4848	GR 01 08/01
09112	381 401 0771 cpl	GR 40 01/02	10073	000 295 0918	GR 29 03/01
09113	381 401 0771 N	GR 40 01/02	10078	009 997 5246	GR 35 05/03
09114	317 402 0175	GR 40 01/01	10082	422 997 0040	GR 01 08/02
09115	074 361 022 351	GR 40 01/01	10083	000 090 6050	GR 09 01/06
09547		GR 26 06/02	10084	000 090 0751	GR 09 01/06
09600	000 261 5680	GR 26 06/06	10085	000 092 3303	GR 09 01/07
09605	000 290 0667	GR 29 03/02	10086	000 092 3303cpl	GR 09 01/07
09606		GR 43 02/02	10115	346 334 0080	GR 35 05/01
09614	355 180 1165	GR 18 01/01	10117	004 981 2405	GR 35 07/02
09615	013 997 1447	GR 01 08/01	10118	004 981 0705	GR 35 07/02
09616	016 997 5647	GR 35 05/01	10119	004 981 2105	GR 35 07/03
09617	013 997 9447	GR 35 05/01	10120	363 410 0151	GR 41 02/01
09668	912 009 035 100	GR 25 01/02	10122	003 091 4201	GR 09 01/07
09669	000 988 036 100	GR 25 01/02	10124	000 090 3550	GR 09 01/07
09670	002 992 1501	GR 25 01/02	10151	385 410 0231	GR 41 01/01
09671	655 254 0206	GR 25 01/02	10153	385 410 0131	GR 41 01/01
09672	304 017 012 011	GR 25 01/03	10155	304 410 0031	GR 41 01/01
09673	655 254 0206A	GR 25 01/02	10156	381 410 0531	GR 41 01/01
09691	542 201 0180	GR 20 01/03	10164	335 410 0031	GR 41 01/01
09692	541 011 0059	GR 01 05/01	10165	363 410 0631	GR 41 01/02
09694	906 017 0260	GR 01 02/02	10166	387 410 0031	GR 41 01/02
09739	541 053 1731	GR 05 03/01	10167	656 410 0031	GR 41 01/02
09748	000 241 0513	GR 24 01/01	10180	346 353 1762	GR 35 05/02
09749	000 242 1213	GR 24 01/01	10214	403 030 1405	GR 03 03/01
09750	343 241 0013	GR 24 01/01	10215	442 030 0205	GR 03 03/01
09751	645 240 0418	GR 24 01/01	10216	441 030 0405	GR 03 03/02
09753	617 240 0318	GR 24 01/01	10217	403 200 0926	GR 20 03/01
09754	361 266 0184	GR 26 02/01	10220	442 030 1905	GR 03 03/02
09755	941 241 5713	GR 24 01/03	10248	000 429 3795	GR 43 02/02
09756	620 240 0717	GR 24 01/02	10249	000 429 1431	GR 42 07/01
09757	658 241 0013	GR 24 01/02	10262	387 501 2982t	GR 50 04/01
09762	000 586 2846	GR 46 01/01	10275	402 130 0308	GR 13 02/01
09763	000 260 0296	GR 26 02/01	10276	442 130 0008	GR 13 02/01
09764	366 586 5446	GR 46 01/02	10277	441 130 0008	GR 13 02/01
09813	005 429 1044	GR 42 07/02	10296	442 038 0150	GR 03 02/01
09827	541 010 0205	GR 01 03/07	10297	442 038 0050	GR 03 02/01
09828	541 015 0160	GR 01 06/02	10349	656 505 0286	GR 50 05/01
09829	541 184 0780	GR 18 03/02	10350	620 505 0086	GR 50 05/01
09830	942 501 0080	GR 20 01/04	10351	403 150 0572	GR 15 02/02
09831	541 015 1180	GR 01 06/01	10649		GR 01 08/02
09832	541 015 1280	GR 01 06/01	10650		GR 01 08/02
09833		GR 01 06/01	10652	941 501 0382	GR 50 04/01
09834	541 131 0780	GR 13 01/08	10653	620 501 3782	GR 50 04/01
09835	024 997 2848	GR 01 08/01	10654	346 501 5182	GR 50 04/01
09836	541 188 0080	GR 18 03/02	10655	641 760 0004	GR 76 02/01
09838		GR 01 03/09	10833		GR 15 01/01
09840	442 141 0780	GR 01 07/01	10834	000 151 0633	GR 15 01/01
09843		GR 01 03/09	10835	000 152 4010	GR 15 01/01
09899	001 997 6848	GR 35 05/01	10836	000 152 4210	GR 15 01/01
09928		GR 01 03/02	10837	000 151 4050	GR 15 01/01
09945	641 760 0259	GR 76 01/01	10838	000 151 4150	GR 15 01/02

## MERCEDES

KTK	RF: No.	Page	KTK	RF: No.	Page
10839	000 151 7614	GR 15 01/02	11032	001 250 0615	GR 25 02/03
10840	000 151 4015	GR 15 01/02	11033	001 250 4715	GR 25 02/04
10842	000 151 3915	GR 15 01/02	11035	355 200 1501	GR 20 01/01
10843		GR 15 01/02	11036	403 200 4901	GR 20 01/02
10844	000 151 7055	GR 15 01/03	11037	403 200 7901	GR 20 01/02
10846	001 152 3010	GR 15 01/03	11038	422 200 1201	GR 20 01/03
10847		GR 15 01/03	11039	542 200 2001	GR 20 01/03
10848	000 154 1705	GR 15 01/05	11040	541 200 1201	GR 20 01/04
10849	005 154 5102	GR 15 02/01	11041	542 200 1901	GR 20 01/04
10850	009 154 0702	GR 15 02/01	11042	355 180 0101	GR 18 04/01
10851	003 151 4101	GR 15 01/03	11043	355 180 1601	GR 18 04/01
10852	620 540 0045	GR 54 01/01	11044	403 180 1701	GR 18 04/01
10853	620 540 0145	GR 54 01/01	11045	423 180 0501	GR 18 04/01
10854	655 540 0045	GR 54 01/02	11046	541 180 0201	GR 18 04/01
10857	003 545 8324	GR 54 01/01	11047	542 180 0101	GR 18 04/02
10858	005 545 5124	GR 54 01/01	11050	423 200 0104	GR 20 01/03
10860	001 544 7432	GR 54 05/01	11097	541 030 0105	GR 03 03/02
10867		GR 01 08/02	11098	345 030 0205	GR 03 03/01
10870	001 990 7368	GR 99 01/01	11099	541 053 0532	GR 05 03/01
10872	000 980 9702	GR 35 07/01	11100	541 131 0680	GR 13 01/08
10873	001 980 2602	GR 35 07/02	11101	541 131 0131	GR 13 01/08
10874	003 981 3205	GR 35 07/02	11102		GR 13 01/08
10875		GR 35 07/02	11104	346 990 0719	GR 14 02/01
10877	004 981 2125	GR 03 04/01	11105	385 268 1474	GR 26 02/02
10878	541 054 0505	GR 05 05/01	11108	000 430 9581	GR 43 01/08
10910	002 429 8744	GR 42 07/01	11110	003 431 5406	GR 43 01/03
10911	000 430 8581	GR 43 01/06	11111	000 260 6957	GR 26 03/01
10913	001 997 6136	GR 43 01/06	11114	000 860 3226	GR 86 01/01
10914	001 260 6757	GR 26 03/01	11115	000 869 3121	GR 86 01/01
10915	000 072 0112	GR 07 03/01	11117	001 420 5283	GR 42 01/01
10916	000 072 1512	GR 07 03/01	11118	000 254 0047	GR 29 03/02
10917	002 429 9244	GR 42 07/01	11119	000 290 1747	GR 29 03/02
10918	000 260 4663	GR 26 05/01	11120	002 431 0605	GR 43 01/02
10919	000 260 4763	GR 26 05/01	11125	004 542 5617	GR 54 02/01
10938	002 094 6382	GR 09 03/01	11126	002 542 1717	GR 54 02/01
10939	002 094 5282	GR 09 03/01	11127	004 542 4317	GR 54 02/01
10940	000 325 0596	GR 32 02/01	11128	004 542 8917	GR 54 02/01
10941	541 130 0008	GR 13 02/01	11129	001 542 8716	GR 54 03/01
10973	001 545 0626	GR 54 06/01	11130	001 542 4503	GR 54 03/01
10974	004 545 2128	GR 54 06/01	11131	003 542 3305	GR 54 03/01
10975	387 540 0139	GR 54 06/01	11132	001 542 9902	GR 54 03/01
10987	011 997 7246	GR 46 01/02	11133	001 542 4202	GR 54 03/01
10988		GR 46 01/02	11134	000 542 8703	GR 54 03/02
10989	013 997 7347	GR 26 06/09	11168	655 241 0713	GR 24 01/03
10990	013 997 7247	GR 26 06/09	11169	655 241 0613	GR 24 01/03
10991	000 267 0197	GR 26 06/10	11171	541 050 0622	GR 05 04/01
11009	403 030 1305	GR 03 03/01	11172	942 504 0214	GR 50 01/02
11010	355 030 1305	GR 03 03/01	11197	000 325 0496	GR 32 02/01
11018	001 250 4815	GR 25 02/03	11248	501 131 1511	GR 13 01/09
11021	000 250 1915	GR 25 02/02	11398	620 997 0490	GR 49 02/01
11022	000 250 6415	GR 25 02/03	11399	620 997 0590	GR 49 02/01
11023	000 250 4215	GR 25 02/02	11400	621 997 0090	GR 49 02/02
11025	320 250 0015	GR 25 02/02	11432	006 981 6305	GR 35 07/03
11026	340 250 0215	GR 25 02/02	11433	007 993 012 100	GR 25 01/01
11029	000 250 7515	GR 25 02/03	11434	655 250 0069cpl	GR 25 01/01
11030	000 250 7315	GR 25 02/03	11454	000 434 3801	GR 43 01/03
11031	000 250 9215	GR 25 02/02	11455	001 431 7815	GR 43 02/01
			11522	000 154 5414	GR 15 01/06
			11523	000 154 7114	GR 15 01/06

## MERCEDES

KTK	RF: No.	Page	KTK	RF: No.	Page
11608		GR 01 03/08	12096	542 200 0104	GR 20 01/04
11609		GR 01 03/09	12097	542 200 0701	GR 20 01/04
11610	403 586 5190	GR 01 03/09	12112	387 586 9950	GR 35 05/04
11622	326 990 0101	GR 01 02/02	12250	003 431 8205	GR 43 01/09
11625		GR 26 06/10	12251		GR 43 01/09
11630		GR 01 03/07	12255	000 430 7881	GR 43 01/08
11633	403 017 0271	GR 01 02/02	12256	000 429 1795	GR 42 07/03
11647	346 010 0180	GR 01 03/10	12257	001 429 2444	GR 42 07/03
11648	355 201 0178	GR 01 08/02	12258	000 430 0970	GR 43 01/08
11650	355 586 0590	GR 01 03/10	12263	002 460 6780	GR 46 01/01
11651	315 030 0080	GR 01 08/03	12264	000 466 6701	GR 46 01/01
11652	016 997 8248	GR 01 08/03	12266	001 429 5244	GR 42 07/03
11654	011 997 5747	GR 01 08/03	12267	006 420 5318	GR 42 11/02
11655	003 997 4046	GR 01 08/03	12289	346 353 0124	GR 35 05/04
11760	903 410 0010	GR 41 02/02	12290	346 353 2551	GR 35 05/04
11766	312 053 0127	GR 05 03/02	12335	000 431 2215	GR 43 02/01
11767		GR 05 03/02	12336		GR 43 02/01
11768	422 053 0026	GR 05 03/02	12341		GR 43 02/01
11769	541 055 0620	GR 05 06/01	12342		GR 43 02/01
11770	403 055 0220	GR 05 06/01	12407	658 421 0001	GR 42 08/02
11771	381 723 0201	GR 76 02/01	12445		GR 49 02/03
11772	381 723 0301	GR 76 02/01	12446		GR 49 02/03
11773	941 720 0446	GR 72 01/01	12585	015 997 4947	GR 35 05/02
11774	624 300 0304	GR 30 02/01	12586	015 997 474	GR 35 05/03
11775	381 725 0060	GR 72 02/01	12587	020 997 0547	GR 35 05/02
11776	000 471 1230	GR 09 06/01	12589		GR 35 05/02
11777	941 760 0459	GR 76 01/01	12796	000 501 4215	GR 50 03/01
11778	941 760 0559	GR 76 01/01	12797	000 501 4615	GR 50 03/01
11779	000 501 6415	GR 50 03/01	12815	000 331 0385	GR 33 01/01
11780	673 760 0002	GR 72 02/01	12985	641 720 0095	GR 72 02/01
11781	381 766 0901	GR 76 01/01	12986	641 720 0195	GR 72 02/01
11790	403 055 0650	GR 05 06/01	13215	003 205 0106	GR 20 03/01
11849	381 401 0771	GR 40 01/02	13216	003 205 0006	GR 20 03/01
11850	389 401 0071	GR 40 01/01	13217	003 205 3606	GR 20 03/01
12071	000 350 0113	GR 35 02/01	13218	002 205 7006	GR 20 03/01
12072	385 997 0582	GR 25 01/01	13219	002 205 0306	GR 20 03/02
12074	004 981 5801	GR 26 08/01	13225	403 180 3938	GR 18 02/01
12078	004 981 1705	GR 35 07/03	13226	403 180 2438	GR 18 02/01
12079	002 981 7201	GR 26 08/01	13227	442 188 1604	GR 18 02/01
12080		GR 26 08/01	13228	541 188 1204	GR 18 02/01
12081	008 981 2805	GR 26 08/01	13258	645 410 0131	GR 41 01/02
12082	012 981 9305	GR 26 08/01	13307		GR 42 11/01
12083	011 981 1305	GR 26 08/02	13308		GR 42 11/01
12084	012 981 9205	GR 26 08/02	13319		GR 99 03/04
12085		GR 26 08/03	13320		GR 99 03/04
12086	005 981 8701	GR 26 08/02	13321	000 430 4926	GR 07 03/01
12087	004 981 7801	GR 26 08/02	13322	000 540 6339	GR 54 06/01
12088		GR 26 08/02	13323	000 545 4084	GR 54 06/02
12089		GR 26 08/03	13324	422 180 0315	GR 18 03/02
12090	363 410 0051	GR 41 02/02	13363	000 018 3835	GR 18 03/02
12091	002 420 4920	GR 42 10/01	13364	000 018 3735	GR 18 03/03
12092	074 310 013 002	GR 99 02/01	13365	001 460 7948	GR 46 04/06
12093	355 200 1204	GR 20 01/01	13366	000 460 1748	GR 46 04/06
12094	355 200 1401	GR 20 01/01	13367	000 996 6745	GR 26 07/01
12095	403 200 6901	GR 20 01/02	13368	000 996 6645	GR 26 07/01
			13369	375 260 0537	GR 26 07/02
			13372	000 996 6845	GR 26 07/02
			13373	000 996 5645	GR 26 07/02
			13374	000 996 5545	GR 26 07/02

## MERCEDES

KTK	RF: No.	Page	KTK	RF: No.	Page
13536	000 074 7684	GR 07 01/01	14309	942 401 0371	GR 40 01/03
13715	000 268 7045	GR 26 07/03	14776	000 267 2119	GR 26 09/01
			14777	945 267 1119	GR 26 09/01
13717	656 411 0012	GR 41 02/02	14778	000 267 0519	GR 26 09/01
13718	659 411 0112	GR 41 02/02	15041	346 993 0810	GR 42 06/01
13719	654 411 0012	GR 41 02/03	15079	541 014 0722	GR 01 03/08
13720	973 411 0012	GR 41 02/03	15080	542 014 0322	GR 01 03/07
13774	000 268 5989	GR 26 07/02	15081	542 014 0122	GR 01 03/08
13775	000 996 4845	GR 26 07/03	15082	542 010 0205	GR 01 03/07
13782	655 330 0019	GR 33 02/01	15083	542 010 0405	GR 01 03/08
13783	001 981 7818	GR 33 02/01	15084	541 010 0505	GR 01 03/08
13785	009 981 3810	GR 33 02/02	15103	402 130 0320	GR 13 01/04
13786		GR 33 02/02	15104	402 130 0320/P	GR 13 01/05
13787		GR 33 02/02	15138	002 094 5782	GR 09 03/01
13788	655 330 0419	GR 33 02/02	15173	002 460 0880	GR 46 01/01
13789		GR 33 02/03	15347	000 130 6915	GR 13 01/09
13790	020 997 4947	GR 33 02/03	15348	001 130 2815	GR 13 01/10
13791	942 332 0162	GR 33 02/03	15349	001 130 1215	GR 13 01/10
13792	655 330 0619	GR 33 02/03	15351	000 130 6815	GR 13 01/09
13793	942 980 0110	GR 33 02/04	15352	000 130 7615	GR 13 01/10
13794	655 330 0519	GR 33 02/04	15363	000 252 0646	GR 25 02/04
13795	942 332 0006	GR 33 02/01	15364	000 252 0643	GR 25 02/04
13796	655 330 0019A	GR 33 02/01	15368		GR 25 02/04
13797	655 330 0419A	GR 33 02/02	15403	001 460 0548	GR 46 04/05
13798	655 330 0619A	GR 33 02/03	15404	001 460 1748	GR 46 04/05
13799	655 330 0519A	GR 33 02/04	15465	906 010 1313	GR 01 01/02
13866	008 545 0124	GR 54 01/01	15483	387 240 0017	GR 24 01/02
14203	541 030 0520	GR 03 01/01	15485	941 323 0050	GR 35 02/02
14202	000 267 0514	GR 26 02/01	15486	000 350 0213 F	GR 35 02/01
14204		GR 20 02/01	15495	318 586 0031	GR 31 01/02
14208	004 151 8801	GR 15 01/04	15508	000 322 3285	GR 32 01/01
14209	000 150 6015	GR 15 01/04	15517	019 997 0547	GR 26 06/10
14210	001 152 3210	GR 15 01/04	15539	946 356 0015	GR 35 05/02
14211		GR 15 01/04	15540	942 421 2112	GR 42 09/01
14212	000 150 1031	GR 15 01/05	15758		GR 41 01/02
14213	005 151 5001	GR 15 01/05	15799	645 528 0182	GR 09 04/01
14214	001 152 6310	GR 15 01/05	15819	541 188 0201	GR 18 01/02
14218	000 152 9310	GR 15 01/05	15829	020 997 0647	GR 35 05/03
14220	000 151 7914	GR 15 01/06	15936	541 070 0646	GR 07 01/01
14221	012 154 0402	GR 15 02/01	16111	000 295 0818	GR 29 03/02
14222	000 154 2705	GR 15 02/02	16112	000 254 0147	GR 29 03/03
14223	001 154 3616	GR 15 02/02	16115	000 295 0018	GR 29 03/03
14250	000 987 5127	GR 99 04/02	16135	002 250 3015	GR 25 02/05
14273	442 010 0620	GR 01 02/01	16136	002 250 5515	GR 25 02/05
14274	352 017 0053	GR 01 02/02	16253	002 460 4405	GR 46 04/02
14275	001 553 3505	GR 55 01/01	16254	002 460 4705	GR 46 04/02
14276	001 553 4205	GR 55 01/01	16257	541 130 0620	GR 13 01/09
14277	000 553 7901	GR 55 01/01	16258	541 130 0820	GR 13 01/10
14298	355 353 9850	GR 35 05/04	16364	000 421 0810	GR 42 10/01
14299	346 353 9850	GR 35 05/04	16380	457 200 1470	GR 20 04/01
14303	655 268 0074	GR 26 02/02	16384	906 200 0270	GR 20 04/01
14304	941 326 0050	GR 32 01/02	16385	906 200 1270	GR 20 04/01
14305	013 997 7346	GR 35 05/01	16386	541 200 1670	GR 20 04/02
14306	021 997 5347	GR 01 08/01	16395	541 200 1870	GR 20 04/01
14307	000 997 8152	GR 46 02/01	16396	541 200 1170	GR 20 04/02
14308	942 401 0271	GR 40 01/03			

## MERCEDES

KTK	RF: No.	Page	KTK	RF: No.	Page
16397	541 200 1570	GR 20 04/02	18556	002 460 6105	GR 46 04/02
16398	000 550 1633	GR 20 04/01	18597	000 130 3417	GR 13 03/01
16402	541 010 0713	GR 01 01/02	18598		GR 13 03/01
16558	915 047 008 100	GR 99 01/03	18599		GR 13 03/01
16559		GR 99 01/03	18735	000 350 2205	GR 35 02/01
16560	003 910 010 000	GR 99 01/03	18736	000 350 2305	GR 35 02/02
16584	541 015 1380	GR 01 06/03	18737	000 350 2405	GR 35 02/02
16720	001 553 3601	GR 55 01/02	18754	476 050 0025	GR 05 04/01
16721	001 553 3701	GR 55 01/02	18890	422 200 1101	GR 20 01/03
16853	389 421 0136	GR 42 03/01	18962	000 130 2619	GR 13 01/04
16854	389 421 0236	GR 42 03/01	18963	442 130 0720	GR 13 01/06
17085	000 420 0092	GR 42 02/01	18964	407 130 0519	GR 13 01/07
17100	655 330 0719	GR 33 02/04	18965	441 130 0120	GR 13 01/06
17101	655 330 0719A	GR 33 02/04	18970	442 131 0119	GR 13 01/06
17175	940 350 0335	GR 35 04/01	18971	541 131 0919	GR 13 01/09
17176	346 356 0073	GR 35 04/01	19074	620 401 0700	GR 40 01/03
17177	650 356 0080G	GR 35 04/01	19130	943 820 0156	GR 82 01/03
17178	346 356 0027	GR 35 04/01	19131	943 820 0056	GR 82 01/04
			19132	940 820 0261	GR 82 01/04
17181	940 350 0035	GR 35 04/02	19133	940 820 0161	GR 82 01/04
17196		GR 01 03/09	19134	943 820 1561	GR 82 01/03
17201	000 500 3149	GR 50 02/01	19135	943 820 1461	GR 82 01/03
17202	000 500 3049	GR 50 02/01	19136	943 820 1761	GR 82 01/03
17230	973 490 0165	GR 49 02/02	19137	943 820 1661	GR 82 01/03
17231	970 490 0265	GR 49 02/03	19138	973 820 2761	GR 82 01/04
17232	621 492 0008	GR 49 02/02	19139	973 820 2661	GR 82 01/04
17233	620 492 0208	GR 49 02/02	19161		GR 99 06/02
17234	617 492 0008	GR 49 02/01	19187	002 460 8905	GR 46 04/02
17589	000 540 3839	GR 54 06/01	19188	000 326 4481	GR 32 01/03
17604	007 981 7005	GR 35 07/03	19191	000 323 7985	GR 32 01/03
17656	011 981 6805	GR 35 07/03	19221	945 420 0038	GR 42 02/02
17778	941 820 5461	GR 82 01/01	19222	945 420 0138	GR 42 02/03
17779	941 820 5361	GR 82 01/01	19223	945 420 0238	GR 42 02/03
17780	941 820 5161	GR 82 01/01	19224	945 420 0338	GR 42 02/03
17781	941 820 5261	GR 82 01/01	19225	945 420 0438	GR 42 02/03
17782	941 820 5561	GR 82 01/01	19226	945 420 0938	GR 42 02/03
17783	941 820 5661	GR 82 01/02	19227	016 981 2805	GR 35 07/04
17784	001 540 5870	GR 82 02/01	19228	906 205 0406	GR 20 03/02
17785	001 540 5770	GR 82 02/01	19230	541 010 1072	GR 01 04/01
17786	002 544 1290	GR 82 02/01	19231	457 010 3272	GR 01 04/01
17788	943 820 0161	GR 82 01/02	19341	943 421 0312	GR 42 09/01
17789	943 820 0261	GR 82 01/02	19431	001 260 6357	GR 26 03/01
17790	943 820 0461	GR 82 01/02	19448	941 540 0545	GR 26 03/01
17791	943 820 0361	GR 82 01/02	19449	000 260 4098	GR 26 04/01
18010	381 401 0771A	GR 40 01/02	19450	000 260 6198	GR 26 04/01
18511	315 402 0170	GR 40 01/03	19453	001 260 3463	GR 26 05/01
18512	620 401 0170	GR 40 01/03	19505	000 295 0318	GR 29 03/01
18515	942 490 2219	GR 49 02/04	19506	000 295 0718	GR 29 03/03
18516	942 490 3119	GR 49 02/04	19632	006 420 1420	GR 42 10/01
18517	942 490 3019	GR 49 02/04	19633	000 260 4298	GR 26 05/01
18518	541 140 2203	GR 14 03/01	19669	006 997 6447	GR 26 06/10
18519	541 140 2503	GR 14 03/01	19670	014 997 3647	GR 26 06/10
18542	541 016 1320	GR 01 03/05	19715	001 295 9106	GR 29 02/01
18555	541 016 0421	GR 01 03/05	19716	000 260 4298	GR 26 04/01
			19717	000 260 5998	GR 26 04/01

## MERCEDES















KTK	RF: No.	Page	KTK	RF: No.	Page
19756	002 542 3118	GR 54 02/01	20942	000 500 2149	GR 50 02/01
19781	346 334 0080	GR 35 04/02	21067	001 153 2120	GR 15 03/01
19781	346 334 0080	GR 35 04/02	21100	942 330 0403	GR 33 01/01
19792	000 431 3615	GR 43 02/02	21101	942 330 1103	GR 33 01/01
19810	000 153 9932	GR 15 03/01	21231	000 323 8185	GR 32 01/02
19815	009 542 1017	GR 54 02/02	21232	000 350 2105	GR 35 02/03
19816	005 542 9417	GR 54 02/02	21233	000 326 2481	GR 32 01/03
19817	013 542 6217	GR 54 02/02	21234	000 326 2681	GR 32 01/03
19818	012 542 5617	GR 54 02/02	21235	000 350 3605	GR 35 02/03
19819	004 153 1828	GR 15 03/01	21236	000 350 3705	GR 35 02/03
19820	004 153 7028	GR 15 03/01	21237	000 350 0511	GR 35 02/03
19821	001 542 3318	GR 54 02/02	21238	000 350 2005	GR 35 02/03
19823	942 542 0217	GR 54 02/03	21239	000 350 1313	GR 35 02/04
19824	000 542 9118	GR 54 02/03	21240	000 325 0285	GR 31 01/03
19825	001 545 7309	GR 54 04/02	21241	000 322 0985	GR 31 01/03
19826	001 545 4909	GR 54 04/02	21242	942 317 1812	GR 31 01/01
19827	001 545 1709	GR 54 04/03	21505	457 200 1970	GR 20 04/02
19828	655 542 0017	GR 54 02/03	21536	002 544 1690	GR 82 02/02
19864	003 544 5032	GR 54 05/01	21548	906 030 3205	GR 03 03/02
19870	000 466 4502	GR 46 03/01	21549	006 151 2203	GR 15 01/04
19912	000 470 0405	GR 09 06/01	21550	012 154 6802	GR 15 02/01
19942	541 070 1133	GR 07 02/01	21551	007 151 0201	GR 15 01/03
19980	000 330 0207	GR 35 02/02	21554	002 460 9605	GR 46 04/03
19985	940 350 0235	GR 35 04/02	21555	002 460 2405	GR 46 04/03
19986	940 350 0435	GR 35 04/02	21556	000 460 9305	GR 46 04/03
19987	940 350 0535	GR 35 04/02	21557	000 460 9505	GR 46 04/04
19988	940 350 0635	GR 35 04/03	21558	972 460 1405	GR 46 04/03
19989	940 350 0835	GR 35 04/03	21559	974 460 1005	GR 46 04/04
19990	942 356 0715	GR 35 04/03	21560	974 460 0405	GR 46 04/04
19991	941 720 0546	GR 72 01/02	21561	972 460 1005	GR 46 04/04
19992	00 725 0002	GR 72 01/02	21562	001 460 5105	GR 46 04/04
19993	000 725 0102	GR 72 01/02	21563	001 460 4905	GR 46 04/05
19994	006 420 5320	GR 42 10/01	21564	002 460 5105	GR 46 04/05
20004	000 826 2156	GR 82 02/01	21565	002 460 4905	GR 46 04/05
20005	000 826 2056	GR 82 02/01	21566	949 330 1603	GR 33 01/02
20301	000 460 9805	GR 46 04/03	21578	001 553 3605	GR 55 01/01
20304	004 091 0501	GR 09 02/01	21580	000 470 0469	GR 09 01/08
20380	403 201 1631	GR 20 01/05	21597	012 420 0018	GR 42 11/02
20383	541 201 0180	GR 20 01/05	21598	012 420 7318	GR 42 11/02
20490	000 330 1411	GR 35 02/02	21599	018 420 5318	GR 42 11/02
20561		GR 82 02/02	21600	015 420 4318	GR 42 11/02
20562		GR 82 02/02	21601	015 420 4418	GR 42 11/03
20573	345 401 0070	GR 40 01/04	21602	015 420 7518	GR 42 11/03
20574	620 402 0068	GR 40 01/04	21776		GR 99 06/05
20582	000 500 2249	GR 50 02/01	21777		GR 99 06/05
20682	004 429 0644	GR 42 07/02	21778		GR 99 06/05
20686	000 328 4530	GR 32 03/01	21779		GR 99 06/05
20688	010 542 7818	GR 54 02/04	21780		GR 99 06/05
20703	004 429 8744	GR 42 07/01	21781		GR 99 06/06
20704	000 760 0378	GR 42 07/01	21782		GR 99 06/06
20897		GR 99 08/01	21783		GR 99 06/06
20898		GR 99 08/01	21784		GR 99 06/06
			21785	030 997 1748	GR 99 01/01
			21786	673 997 0145	GR 99 01/01
			21787	000 997 0834	GR 99 01/01

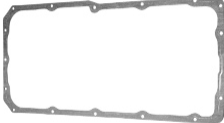



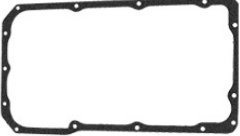

## MERCEDES











KTK	RF: No.	Page	KTK	RF: No.	Page
21788	000 997 0934	GR 99 01/02	23737	457 188 0280	GR 18 03/03
21797	003 820 5042	GR 82 04/01	23757	019 420 7718	GR 42 11/03
21798	973 720 0346	GR 72 01/02	23758	019 420 7818	GR 42 11/03
21799	973 720 0446	GR 72 01/02	23759	019 420 8118	GR 42 11/03
21800	005 820 9142	GR 82 03/01	23760	019 420 8218	GR 42 11/04
21801	005 820 9042	GR 82 03/02	23761	016 420 4118	GR 42 11/04
21804	000 820 4908	GR 82 03/01	23762	019 420 9118	GR 42 11/04
21805	000 820 5008	GR 82 03/01			
21806	000 820 5108	GR 82 03/01			
21807	000 820 5208	GR 82 03/01			
21900	403 018 1182	GR 18 03/03			
21901	617 501 4982	GR 50 04/02			
21902	655 501 1082	GR 50 04/02			
21903	620 501 1082	GR 50 04/02			
21904	617 501 0082	GR 50 04/03			
21905	620 501 2982	GR 50 04/03			
21906	655 501 1282	GR 50 04/03			
21907	941 501 0282	GR 50 04/03			
21908	942 466 0481	GR 46 02/01			
21909	942 466 0281	GR 46 02/01			
21910	942 506 1635	GR 50 04/03			
21911	942 506 4135	GR 50 04/04			
21912	942 501 1582	GR 50 04/04			
21913	942 528 1282	GR 09 04/02			
21913	942 528 1282	GR 52 01/01			
21914	942 501 1682	GR 50 04/01			
21915	942 501 0682	GR 50 04/02			
21916	942 506 3235	GR 50 04/02			
21933	624 528 0282	GR 09 04/01			
21934	941 528 0882	GR 09 04/01			
21939	002 094 6982	GR 09 03/01			
22015	001 830 0208	GR 83 01/01			
22017	003 830 0508	GR 83 01/01			
22018	001 830 8708	GR 83 01/01			
22019	002 830 8408	GR 83 01/01			
22023	941 300 0104	GR 30 02/01			
22095	940 501 0003	GR 50 02/01			
22098	357 500 0249	GR 50 02/02			
22102	002 250 4015	GR 25 02/05			
22106	002 460 8880	GR 46 01/01			
22108	009 154 1502	GR 15 02/01			
22110	001 542 9218	GR 54 02/03			
22113	004 542 4618	GR 54 02/03			
22160	002 295 0406	GR 29 02/01			
22161	002 295 0706	GR 29 02/01			
22162	001 295 7406	GR 29 02/01			
22411		GR 01 03/10			
22421	001 154 9106	GR 15 01/06			
22586	355 015 0020	GR 01 06/03			
22590	497 421 0074	GR 42 01/01			
22628	011 997 7782	GR 09 04/02			
23497	960 820 0539	GR 82 01/05			
23498	960 820 0439	GR 82 01/05			
23499	960 820 0939	GR 82 01/05			
23500	960 820 0839	GR 82 01/05			





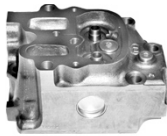























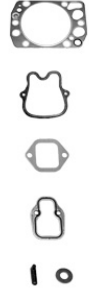





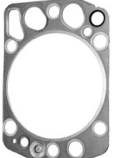













KTK No.	RF No.	Bezeichnung Description Désignation	Erläuterungen Remarks Remarques
06494	 4 057822 064945		
		355 010 0280 355 010 0027 355 586 0001	Dichtsatz, Ölwanne Gasket kit, Oil pan Kit de joints, carter d'huile  L - series
06493	 4 057822 064938		
		441 014 0022 441 014 0422	Dichtung, Ölwanne Gasket kit, Oil pan Joint, carter d'huile  SK/MK/NG series
06508	 4 057822 065089		
		442 014 0222 442 014 0422 442 014 0622 402 014 0222	Dichtung, Ölwanne Gasket kit, Oil pan Joint, carter d'huile  SK/MK/NG series
07599	 4 057822 075996		
		443 014 0022	Dichtung, Ölwanne Gasket kit, Oil pan Joint, carter d'huile  SK/NG series
08482	 4 057822 084820		
		541 014 0322 541 014 0222	Dichtung, Ölwanne Gasket kit, Oil pan Joint, carter d'huile  ACTROS











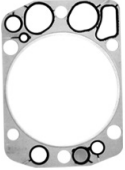

KTK No.	RF No.	Bezeichnung Description Désignation	Erläuterungen Remarks Remarques
15465			
 4 057822 154653			
 	906 010 1313	Ölwanne Oil pan Carter d'huile	ATEGO AXOR
16402			
 4 057822 164027			
 	541 010 0713	Ölwanne Oil pan Carter d'huile	ACTROS





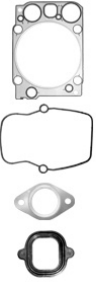

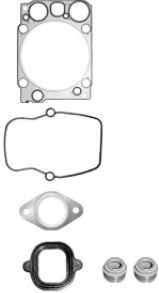



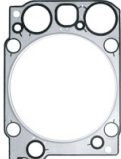

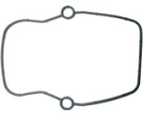
KTK No.		RF No.	Bezeichnung Description Désignation	Erläuterungen Remarks Remarques
08652	 4 057822 086527			
		355 010 0220 355 010 0820	Zylinderkopf, ohne ventile Cylinder head, without valve Culasse, sans valve	L - series Ordinary
08654	 4 057822 086541			
		355 010 0620 355 010 0020	Zylinderkopf, ohne ventile Cylinder head, without valve Culasse, sans valve	L - series Turbo
08653	 4 057822 086534			
		422 010 0020 427 010 0120 429 010 0220	Zylinderkopf, ohne ventile Cylinder head, without valve Culasse, sans valve	SK/MK/NG series
14273	 4 057822 142735			
		442 010 0620	Zylinderkopf, ohne ventile Cylinder head, without valve Culasse, sans valve	MK/SK series 440/445/446

KTK No.		RF No.	Bezeichnung Description Désignation	Erläuterungen Remarks Remarques
07411	 4 057822 074111			
		107 991 0041	Hülse Sleeve Douille	SK/MK/NG series
11633	 4 057822 116330			
		403 017 0271 403 017 0171 403 017 0071	Hülse, Düsenhalter Sleeve, Nozzle holder Douille, support gicleur	M28x1.5 MK/SK/NG series 401/402/403
11622	 4 057822 116224			
		345 990 8901 326 990 0101	Zylinderkopf schraube Cylinder head screw Vis de culasse	L series OM355
14274	 4 057822 142742			
		352 017 0053	Abstandhülse Spacer sleeve Entretoise	L series OM355
09694	 4 057822 096946			
		906 017 0260 541 017 0260	Scheibe Washer / Rondelle	ACTROS











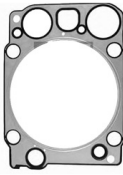

KTK No.		RF No.	Bezeichnung Description Désignation	Erläuterungen Remarks Remarques
07597	 4 057822 075972			
		423 010 0220	Dichtsatz Gasket kit Kit de joints	SK/MK/NG series
08798	 4 057822 087982			
		423 010 0320	Dichtsatz Gasket kit Kit de joints	
06936	 4 057822 069360			
		423 016 0420	Zylinderkopfdichtung Cylinder head gasket Joint de culasse	
06479	 4 057822 064792			
		442 016 0121	Dichtung Gasket Joint	
06492	 4 057822 064921			
		403 142 0380	Dichtung Gasket Joint	





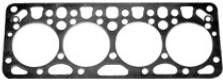

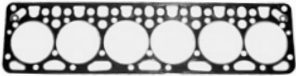







KTK No.		RF No.	Bezeichnung Description Désignation	Erläuterungen Remarks Remarques
06483	 4 057822 064938			
		442 141 0480	Dichtung Gasket Joint	
				
06482	 4 057822 064822			
		346 017 0160	Scheibe Washer Rondelle	
				
07595	 4 057822 075958			
		403 016 0061	Gummikappe Rubber cap Bouchon	
				
07596	 4 057822 075965			
		422 053 0196	Ventilschaftdichtung Valve seal Joint de guide de soupape	
				
09928	 4 057822 099282			
			Dichtsatz Gasket kit Steel type Kit de joints	SK/MK/NG series
				

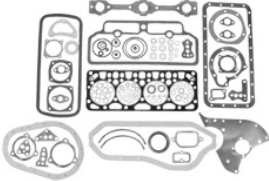









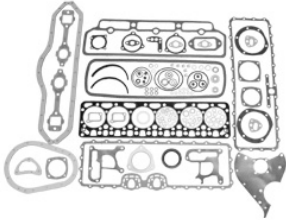

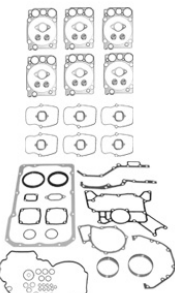
KTK No.	RF No.	Bezeichnung Description Désignation	Erläuterungen Remarks Remarques
08796			
 4 057822 087968			
 	422 016 0620 422 016 0220	Zylinderkopfdichtung Cylinder head gasket Joint de culasse	
08797			
 4 057822 087975			
 	444 010 0120	Dichtsatz Gasket kit Kit de joints	
09061			
 4 057822 090616			
 	442 016 0621 422 016 0721	Dichtung Gasket Joint	
08483			
 4 057822 084837			
 	541 010 1120 541 010 2520	Dichtsatz Gasket kit Kit de joints	ACTROS
09060			
 4 057822 090609			
 		Dichtsatz Gasket kit Kit de joints	

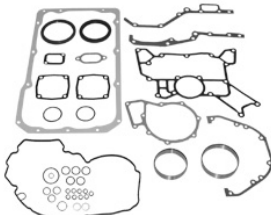

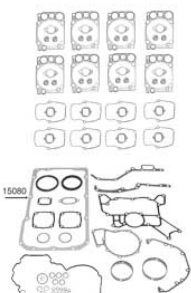







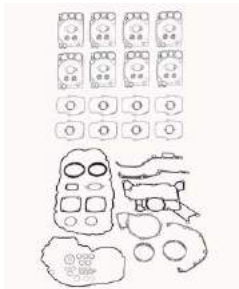



KTK No.		RF No.	Bezeichnung Description Désignation	Erläuterungen Remarks Remarques
08478	 4 057822 084783			
		541 016 0920 541 016 0620	Zylinderkopfdichtung Cylinder head gasket Joint de culasse	501
08479	 4 057822 084790			
		541 016 0321	Dichtung Gasket Joint	
08480	 4 057822 084806			
		541 142 0180 475 142 0080	Dichtung Gasket Joint	
08481	 4 057822 084813			
		541 098 0480	Dichtung Gasket Joint	
09059	 4 057822 090593			
		000 053 3558	Ventilschaftdichtung Valve seal Joint de guide de soupape	

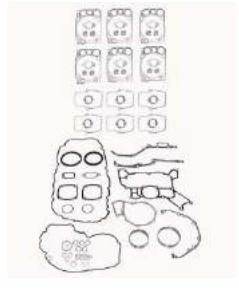





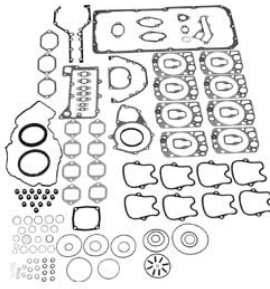





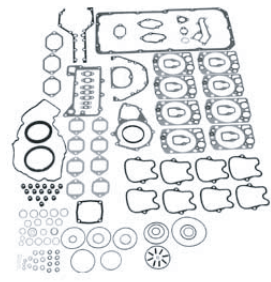

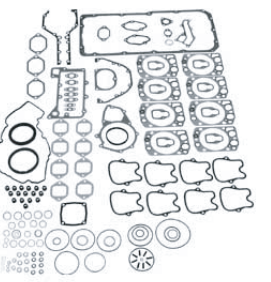



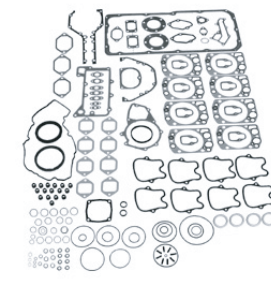

KTK No.		RF No.	Bezeichnung Description Désignation	Erläuterungen Remarks Remarques
18542	 4 057822 185428			
		541 016 1320	Zylinderkopfdichtung Cylinder head gasket Joint de culasse	Actros/Axor
18555	 4 057822 185558			
		541 016 0421	Ventildeckeldichtung Valve cover gasket Joint de cache culbuteur	Actros/Axor
06863	 4 057822 068639			
		346 016 0320 346 016 0120	Dichtung Gasket / Joint	MB - O 317 130 $\varnothing$ OM355
07230	 4 057822 072308			
		364 016 0720 364 016 0620	Dichtung Gasket / Joint	L series
06932	 4 057822 069322			
		366 016 0620 366 016 0720	Dichtung Gasket / Joint	L series

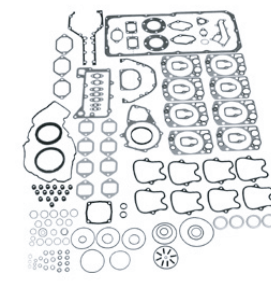
KTK No.	RF No.	Bezeichnung Description Désignation	Erläuterungen Remarks Remarques
06934	 4 057822 069346		
 	352 016 0921 312 016 0921	Dichtung Gasket / Joint	L series
06491	 4 057822 064914		
 	355 016 0021 346 016 0221	Dichtung Gasket / Joint	L series
07228			
 	364 010 0180	Dichtsatz Gasket kit Kit de joints	L series
07229	 4 057822 072292		
 	314 010 0280 364 010 0580 364 010 1280	Dichtsatz Gasket kit / Kit de joints	L series
06933	 4 057822 069339		
 	352 010 0580 352 010 2380 366 010 0780	Dichtsatz Gasket kit / Kit de joints	L series

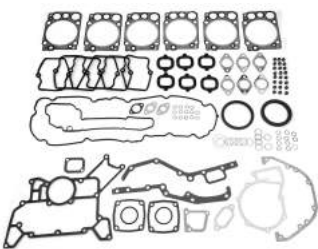
KTK No.	RF No.	Bezeichnung Description Désignation	Erläuterungen Remarks Remarques
06931			
	 4 057822 069315  	352 586 1290  Dichsatz Gasket kit Kit de joints	LP / NG
	 4 057822 116309  	Dichsatz Full Gasket kit Kit de joints	ACTROS/AXOR
	 4 057822 098278  	541 010 0205 541 010 1305 541 010 0505  Dichsatz Half Gasket kit / Kit de joints	
	 4 057822 150822  	542 010 0205  Dichsatz Full gasket kit Kit de joints	ACTROS OM502
	 4 057822 150808  	542 014 0322  Dichtung Gasket Joint	

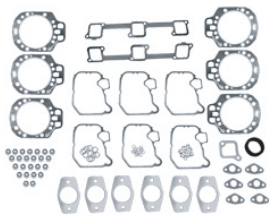
KTK No.	RF No.	Bezeichnung Description Désignation	Erläuterungen Remarks Remarques
15083	4 057822 150839		
	 	542 010 0405	Dichtsatz Full gasket kit Kit de joints  ACTROS OM502
15081	4 057822 150815		
	 	542 014 0122 542 014 0422	Dichtung Gasket Joint
15084	4 057822 150846		
	 	541 010 0505	Dichtsatz Full gasket kit Kit de joints  ACTROS OM501
15079	4 057822 150792		
	 	541 014 0722	Dichtung Gasket Joint  ACTROS OM501
11608	4 057822 116088		
	 		Dichtsatz Gasket kit ordinary Kit de joints  OM 401

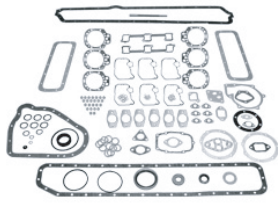
KTK No.	RF No.	Bezeichnung Description Désignation	Erläuterungen Remarks Remarques
<p>09838</p>  <p>4 057822 098384</p>  		<p>Dichtsatz Full Gasket kit Kit de joints</p>	<p>OM 402/422</p>
<p>11610</p>  <p>4 057822 116101</p>  	<p>403 586 5190</p>	<p>Dichtsatz Gasket kit ordinary Kit de joints</p>	<p>OM 403</p>
<p>11609</p>  <p>4 057822 116095</p>  		<p>Dichtsatz Gasket kit ordinary Kit de joints</p>	<p>401/421/441A</p>
<p>09843</p>  <p>4 057822 098438</p>  		<p>Dichtsatz Full Gasket kit Kit de joints</p>	<p>OM 421A 442</p>
<p>17196</p>  <p>4 057822 171964</p>  		<p>Dichtsatz Full Gasket kit Kit de joints</p>	<p>8 CYL Copper type 402</p>

KTK No.	RF No.	Bezeichnung Description Désignation	Erläuterungen Remarks Remarques
<p>22411</p>   <p>4 057822 224110</p> 		<p>Dichsatz Full Gasket kit Kit de joints</p>	<p>OM 501</p>
<p>11647</p>   <p>4 057822 116477</p> 	<p>346 010 0180 355 010 0180</p>	<p>Dichsatz Half Gasket kit Kit de joints</p>	<p>L series OM355</p>
<p>11650</p>   <p>4 057822 116507</p> 	<p>355 586 0590</p>	<p>Dichsatz Full gasket kit Kit de joints</p>	<p>L series OM355</p>

KTK No.	RF No.	Bezeichnung Description Désignation	Erläuterungen Remarks Remarques
19230			
 4 057822 192303			
	 541 010 1072 541 010 0572	Ölmesstab Oil dipstick Jauge de niveau d'huile	Actros 2002 L = 1060mm
19231			
 4 057822 192310			
	 457 010 3272 457 010 0372 457 010 1272	Ölmesstab Oil dipstick Jauge de niveau d'huile	L = 1200mm

KTK No.	RF No.	Bezeichnung Description Désignation	Erläuterungen Remarks Remarques
---------	--------	---	---------------------------------------

06490



541 011 0080  
442 011 0080

Dichtung  
Gasket  
Joint

Actros / Axor  
SK/MK/NG series

06938



442 011 0059

Dichtung, 0.15mm  
Shim, 0.15mm  
Joint, 0.15mm

SK/MK/NG series

09692

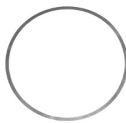





















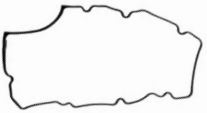







541 011 0059

Dichtung  
Shim  
Joint





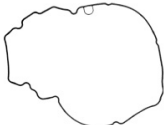









153.3x163.7x0.15  
Actros/Axor



















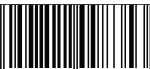









KTK No.		RF No.	Bezeichnung Description Désignation	Erläuterungen Remarks Remarques
09833	 4 057822 098339			
			Dichsatz Gasket kit Kit de joints	ACTROS
				
09831	 4 057822 098315			
		541 015 1180 541 015 1780	Dichtung Gasket Joint	
				
09832	 4 057822 098322			
		541 015 1280 541 015 1680	Dichtung Gasket Joint	
				
06488	 4 057822 064884			
		423 010 4833	Dichtung Gasket Joint	SK/MK/NG series
				
07527	 4 057822 075279			
		403 015 0160	Dichtung Gasket Joint	MK/SK/NG series
				

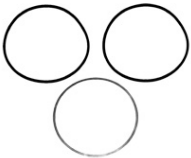

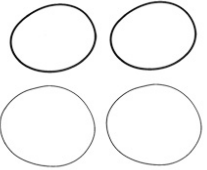

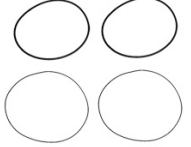







KTK No.		RF No.	Bezeichnung Description Désignation	Erläuterungen Remarks Remarques
07526	 4 057822 075262			
		442 015 0060	Dichtung Gasket Joint	MK/SK/NG series
06929	 4 057822 069292			
		346 015 0120 346 015 0020	Dichtung Gasket Joint	L series
07598	 4 057822 075989			
		356 015 0121 355 015 0021	Dichtung Gasket Joint	L series
10016	 4 057822 100162			
		366 015 0020	Dichtung Gasket Joint	
09828	 4 057822 098285			
		541 015 0160	Dichtung Gasket Joint	ACTROS From Eng. No. 089131















KTK No.	RF No.	Bezeichnung Description Désignation	Erläuterungen Remarks Remarques
16584			
 4 057822 165840			
	541 015 1380	Dichtung Gasket Joint	ACTROS OM541/542 From Eng. No. 089132
22586			
 4 057822 225865			
	355 015 0020	Reparatursatz Repair kit, timing case Jeu de réparation	OM 355

KTK No.		RF No.	Bezeichnung Description Désignation	Erläuterungen Remarks Remarques
06935	 4 057822 069353			
		352 142 0480	Dichtung Gasket Joint	LP / NG 312 / 352 353 / 362
06496	 4 057822 064969			
		346 142 0060 315 142 0060 355 142 0160 355 142 0580	Dichtung Gasket / Joint	L series
07964	 4 057822 079642			
			Dichtung Gasket / Joint	L series
06497	 4 057822 064976			
		355 142 0280 355 141 0280 346 141 0180	Dichtung Gasket / Joint	L series
09840	 4 057822 098407			
		442 141 0780	Dichtung Gasket / Joint	MK/SK/NG series



KTK No.		RF No.	Bezeichnung Description Désignation	Erläuterungen Remarks Remarques
08968	 4 057822 089689			
		014 997 4647 012 997 7447	Wellendichtring Sealring Bague d'etanchéité	105x130x12 ACTROS/AXOR SK/MK/NG
09615	 4 057822 096151			
		013 997 1447 006 997 2647 005 997 2647 014 997 1347	Wellendichtring Sealring Bague d'etanchéité	120x140x13/12 ACTROS/AXOR SK/MK/NG series Front side
14306	 4 057822 143060			
		021 997 5347 025 997 5047	Wellendichtring Sealring Bague d'etanchéité	115x140x13 ACTORS/ATEGO AXOR Rear side
09835	 4 057822 098353			
		024 997 2848 020 997 1148 003 997 5748	O-Ring O-ring / Joint torique	ACTROS/AXOR SK/MK/NG series L series
10072	 4 057822 100728			
		006 997 4848	O-Ring O-ring / Joint torique	61x45x8 SK/MK/NG series















KTK No.		RF No.	Bezeichnung Description Désignation	Erläuterungen Remarks Remarques
10082	 4 057822 100827			
		422 997 0040 007 997 1748	Wellendichtring Sealring Bague d'etanchéité	31.5x22.9x5.9 SK/MK/NG series
10867	 4 057822 108670			
			O-Ring O ring set Liner Joint torique 541 997 1145 - 1 Nos. 541 997 1045 - 1 Nos. 541 011 0059 - 1 Nos.	ACTROS/AXOR 130MM
10649	 4 057822 106492			
			O-Ring Liner O ring set Joint torique	SK/MK/NG series 125MM
10650	 4 057822 106508			
			O-Ring / Joint torique Liner O ring set 015 997 9048 - 2 Nos. 015 997 9148 - 2 Nos.	SK/MK/NG series 128mm
11648	 4 057822 116484			
		355 201 0178	Dichtring Seal Bague d'etanchéité	L series OM355 64x48x16









KTK No.		RF No.	Bezeichnung Description Désignation	Erläuterungen Remarks Remarques
11651	 4 057822 116514			
	 	315 030 0080	Dichtring Seal Bague d'etanchéité	24x52x10 OM355 L series
11652	 4 057822 116521			
	 	016 997 8248 346 997 0445	O-ring O-ring Joint torique	L series OM355
11654	 4 057822 116545			
	 	011 997 5747 001 997 6946 004 997 3947	Wellendichtring Oil seal Bague d'etanchéité	75x100x12/13 L series 327/346 355/360
11655	 4 057822 116552			
	 	003 997 4046	Wellendichtring Oil seal Bague d'etanchéité	26x45x10/7 L series OM355









KTK No.	RF No.	Bezeichnung Description Désignation	Erläuterungen Remarks Remarques
07652	 4 057822 076528		
 	355 030 2820 355 030 2120 355 030 0720 355 030 1320 355 030 1720	Pleuelstange Connecting rod Tige de bielle	L series 355 / 335
07653	 4 057822 076535		
 	422 030 0420 403 030 1720 403 030 0020	Pleuelstange Connecting rod Tige de bielle	SK/MK/NG series Straight head 401/402/403 421/422/442
08562	 4 057822 085629		
 	441 030 0820 441 030 0820	Pleuelstange Connecting rod Tige de bielle	MK/SK series 401/441
07666	 4 057822 076665		
 	442 030 0220	Pleuelstange Connecting rod Tige de bielle	MK/SK/NG series Conical head 442/443
14203	 4 057822 142032		
 	541 030 0520 541 030 0320 541 030 0420	Pleuelstange Connecting rod Tige de bielle	ACTROS/AXOR 521/541/941















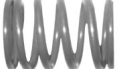











KTK No.		RF No.	Bezeichnung Description Désignation	Erläuterungen Remarks Remarques
10296	 4 057822 102968			
		442 038 0150	Pleuelbuchse Connecting rod bush Douille de bielle	SK/MK/NG series New version
10297	 4 057822 102975			
		442 038 0050	Pleuelbuchse Connecting rod bush Douille de bielle	SK/MK/NG series Old version











KTK No.	RF No.	Bezeichnung Description Désignation	Erläuterungen Remarks Remarques
11010	4 057822 110109		
	 	355 030 1305 Schwungrad Fly wheel Volant moteur	380mm Teeth: 154 L series
11098	4 057822 110987		
	 	345 030 0205 Schwungrad Fly wheel Volant moteur	OM355A 420mm L series
11009	4 057822 110093		
	 	403 030 1305 403 030 1605 Schwungrad Fly wheel Volant moteur	380mm NG series 402/422
10214	4 057822 102142		
	 	403 030 1405 403 030 0850 Schwungrad Fly wheel Volant moteur	420mm SK/MK/NG series Teeth : 160
10215	4 057822 102159		
	 	442 030 0205 Schwungrad Fly wheel Volant moteur Normal	430mm Teeth: 160







KTK No.	RF No.	Bezeichnung Description Désignation	Erläuterungen Remarks Remarques
10220	4 057822 102203		
		442 030 1905 Schwungrad Fly wheel - automatic Volant moteur	430mm Teeth: 160 3cut timing mark
10216	4 057822 102166		
		441 030 0405 Schwungrad Fly wheel Volant moteur	400mm Teeth : 160 NG series
11097	4 057822 110970		
		541 030 0105 Schwungrad Fly wheel Volant moteur	430mm ACTROS/AXOR
21548	4 057822 215482		
		906 030 3205 Schwungrad Fly wheel Volant moteur	Atego

KTK No.		RF No.	Bezeichnung Description Désignation	Erläuterungen Remarks Remarques
10877	 4 057822 108779			
	 	004 981 2125	Rollenlager Bearing, fly wheel Palier à rouleaux	ACTROS SK/MK/NG 25x62x25
08918	 4 057822 089184			
	 	442 031 0027 403 031 0727	Laufring Racer Chemin de roulement	100x105x24 ACTROS/AXOR MK/SK/NG series
08919	 4 057822 089191			
	 	403 032 0309	Laufring Racer Chemin de roulement	115x120x21 ACTROS/AXOR MK/SK/NG series















KTK No.		RF No.	Bezeichnung Description Désignation	Erläuterungen Remarks Remarques
07608	 4 057822 076085			
		352 053 0320 352 053 0420	Ventildfeder Valve spring Ressort de soupape	L series
07609	 4 057822 076092			
		403 053 0120 403 053 0020 403 053 0320	Ventildfeder Valve spring Ressort de soupape	SK/MK/NG series
07407	 4 057822 074074			
		403 053 1122 403 053 0622 403 053 0822	Ventildfeder Valve spring Ressort de soupape	SK/MK/NG series









KTK No.	RF No.	Bezeichnung Description Désignation	Erläuterungen Remarks Remarques
07604	 4 057822 076047		
		355 053 0131 Ventilsitzring, Einlass Valve seat ring, intake Siège de soupape, admission	L series OM 355A
07605	 4 057822 076054		
		355 053 0032 Ventilsitzring, Auslass Valve seat ring, exhaust Siège de soupape, échappement	345/355
09004	 4 057822 090043		
		Reparatursatz Repair kit Jeu de réparation	07604 - 12 Nos. 07605 - 12 Nos.
07600	 4 057822 076009		
		355 053 1131 346 053 0731 Ventilsitzring, Einlass Valve seat ring, intake Siège de soupape, admission	L series
07601	 4 057822 076016		
		355 053 1832 Ventilsitzring, Auslass Valve seat ring, exhaust Siège de soupape, échappement	







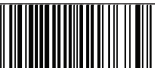

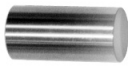

KTK No.	RF No.	Bezeichnung Description Désignation	Erläuterungen Remarks Remarques
<p><b>09005</b></p>  <p>4 057822 090050</p> 		<p>Reparatursatz Repair kit Jeu de réparation</p>	<p>07600 - 12 Nos. 07601 - 12 Nos.</p>
<p><b>07648</b></p>  <p>4 057822 076481</p> 	<p>403 053 0331</p>	<p>Ventilsitzring, Einlass Valve seat ring, intake Siège de soupape, admission</p>	<p>SK/MK/NG series 61.11</p>
<p><b>07930</b></p>  <p>4 057822 079307</p> 	<p>442 053 0032 403 053 2132 442 053 0132</p>	<p>Ventilsitzring, Auslass Valve seat ring, exhaust Siège de soupape, échappement</p>	<p>SK/MK/NG series 53.11</p>
<p><b>09006</b></p>  <p>4 057822 090067</p> 		<p>Reparatursatz Repair kit Jeu de réparation</p>	<p>07648 - 8 Nos. 07930 - 8 Nos.</p>
<p><b>07958</b></p>  <p>4 057822 079581</p> 	<p>422 053 0531</p>	<p>Ventilsitzring, Einlass Valve seat ring, intake Siège de soupape, admission</p>	<p>SK/MK/NG 60.11</p>













KTK No.		RF No.	Bezeichnung Description Désignation	Erläuterungen Remarks Remarques
09007	 4 057822 090074		  Reparatursatz Repair kit Jeu de réparation	07958 - 8 Nos. 07930 - 8 Nos.
09003	 4 057822 090036	442 053 0531	Ventilsitzring, Einlass Valve seat ring, intake Siège de soupape, admission	SK/MK/NG
09008	 4 057822 090081		  Reparatursatz Repair kit Jeu de réparation	09003 - 8 Nos. 07930 - 8 Nos.



















KTK No.	RF No.	Bezeichnung Description Désignation	Erläuterungen Remarks Remarques
07224			
			
4 057822 072247			
	403 053 0052 442 016 0421	Ausgleichscheibe Shim Inner Cale	SK/MK/NG series
			
07225			
			
4 057822 072254			
	403 053 0152	Ausgleichscheibe Shim Cale	
			
07602			
			
4 057822 076023			
	352 053 0296 352 053 0196	Ventilschaftdichtung Valve seal Joint de guide de soupape	LP / NG
			
09739			
			
4 057822 097394			
	541 053 1731	Ventilsitzring Valve seat Siège de soupape	ACTROS/AXOR
			
11099			
			
4 057822 110994			
	541 053 0532	Ventilsitz Valve seat Siège de soupape	ACTROS/AXOR
			

KTK No.		RF No.	Bezeichnung Description Désignation	Erläuterungen Remarks Remarques
11766	 4 057822 117665			
		312 053 0127 343 053 7027	Kegelstück Valve lock New version Clavette	L series
11767	 4 057822 117672			
			Kegelstück Valve lock Clavette	SK/MK/NG Middle lock type OM422
11768	 4 057822 117689			
		422 053 0026	Kegelstück Valve lock Clavette	SK/MK/NG Top lock type OM422





KTK No.		RF No.	Bezeichnung Description Désignation	Erläuterungen Remarks Remarques
07613	 4 057822 076139			
		346 054 0201 345 054 7001 355 054 0101	Vantilstößel Valve tappet Poussoir soupape	L series
07614	 4 057822 076146			
		403 054 1801 403 054 0901	Ventilstößel Valve tappet Poussoir de soupape	SK/MK/NG series
18754	 4 057822 187545			
		476 050 0025 422 050 0325 403 050 0325	Ventilstößel Valve tappet Poussoir de soupape	401/402/441
11171	 4 057822 111717			
		541 050 0622	Ventilstößel Valve tappet Poussoir de soupape	ACTROS/AXOR

KTK No.		RF No.	Bezeichnung Description Désignation	Erläuterungen Remarks Remarques
07610	 4 057822 076108			
		326 054 0605 345 054 7105	Stößelstange, Einlass Push rod intake Tige de culbuteur, admission	L series
07611	 4 057822 076115			
		326 054 0705 345 054 7205	Stößelstange, Auslass Push rod exhaust Tige de culbuteur, échappement	
07612	 4 057822 076122			
		422 054 0105 403 054 0105 403 054 0405	Stößelstange, Einl. und Ausl. Push rod intake and exhaust Tige de culbuteur	SK/MK/NG
10878	 4 057822 108786			
		541 054 0505	Stößelstange Push rod Tige de culbuteur	ACTROS/AXOR

KTK No.	RF No.	Bezeichnung Description Désignation	Erläuterungen Remarks Remarques
11769			
 4 057822 117696			
 	541 055 0620 541 055 0320 541 055 0420	Einstellschraube, Kipphebel Adjusting screw, rocker arm Vis de réglage	ACTROS/AXOR
11770			
 4 057822 117702			
 	403 055 0220 442 055 0020	Einstellschraube, Kipphebel Adjusting screw, rocker arm Vis de réglage	SK/MK/NG 402/423/442
11790			
 4 057822 117900			
 	403 055 0650	Buchse Bush Bague	SK/MK/NG

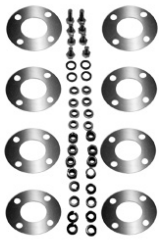
KTK No.	RF No.	Bezeichnung Description Désignation	Erläuterungen Remarks Remarques
15936			
 4 057822 159368	541 070 0646 541 070 0546 541 070 0246	Ventil Return Valve Soupape	ACTROS/AXOR 541/542 941/942
		07620	 4 057822 076207
07620	000 074 0515	überströmventil Overflow valve Clapet anti-retour	LK/LP SK/MK/NG
		07621	 4 057822 076214
07621	000 477 0329	überströmventil Overflow valve Clapet anti-retour	L series
		13536	 4 057822 135362
13536	000 074 7684 001 074 0984 000 074 3884 000 074 6584	Ventil Return valve Soupape	SK/MK/NG LK
			

KTK No.		RF No.	Bezeichnung Description Désignation	Erläuterungen Remarks Remarques
07533	 4 057822 075330			
		403 074 0059	Dichtring Seal ring Bague d'etanchéité	SK/MK/NG 12mm Old version
07636	 4 057822 076368			
		442 074 0059	Dichtring Seal ring Bague d'etanchéité	SK/MK/NG 8mm
07536	 4 057822 075361			
		008 997 6145	O-Ring O-ring / Joint torique	SK/MK/NG 3mm
07642	 4 057822 076429			
		360 077 0180 355 077 0080	Dichtung Gasket / Joint	L series

KTK No.		RF No.	Bezeichnung Description Désignation	Erläuterungen Remarks Remarques
06937	 4 057822 069377		  Reparatursatz Repair kit Jeu de réparation	L series
07638	 4 057822 076382	000 077 0325	Scheibe, Einspritzkupplung Disc, injection coupling Disque, injection	
06470	 4 057822 064709	352 078 0180 352 078 0080	Dichtbügel Twin washer Rondelle	L series



**KTK No.**

19942



**RF No.**













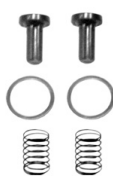

541 070 1133















**Bezeichnung**  
**Description**  
**Désignation**Leitung  
Pipe line  
Conduite**Erläuterungen**  
**Remarks**  
**Remarques**















Actros/Axor

































KTK No.		RF No.	Bezeichnung Description Désignation	Erläuterungen Remarks Remarques
10915	 4 057822 109158	000 072 0112	Zylinder 6mm Cylinder 6mm Cylindre 6mm	L series SK/MK/NG series
10916	 4 057822 109165	000 072 1512 000 072 1812	Zylinder 8mm Cylinder 8mm Cylindre 8mm	L series SK/MK/NG series
13321	 4 057822 133214	000 430 4926 000 430 3026 000 430 4826 000 430 3226	Zylinder Cylinder / Cylindre	L series SK/MK/NG series















KTK No.		RF No.	Bezeichnung Description Désignation	Erläuterungen Remarks Remarques
07618	 4 057822 076184			
		000 091 1280 001 074 2280 000 091 1880	Dichtung Gasket Joint	SK/MK/NG
07408	 4 057822 074081			
		000 090 0210 000 586 1307	Reparatursatz, Förderpumpe Repair kit, feed pump Kit de réparation, pompe d'alimentation	L series SK/MK/NG
07625	 4 057822 076252			
		000 091 0910	Ventil Valve Soupape	
06514	 4 057822 065140			
			Scheibe Washer Rondelle	
07627	 4 057822 076276			
		000 091 0319	Feder Spring Ressort	

KTK No.	RF No.	Bezeichnung Description Désignation	Erläuterungen Remarks Remarques
07655			
  	4 057822 076559	000 090 0610 Reparatursatz Repair kit Kit de réparation	SK/MK/NG
07409			
  	4 057822 074098	000 090 0151 Reparatursatz Repair kit Kit de réparation	L series SK/MK/NG series
07628			
  	4 057822 076283	000 091 0840 000 091 0640 Reparatursatz Repair kit Kit de réparation	L seires SK/MK/NG series
07629			
  	4 057822 076290	000 091 0039 Kraftstofffilter Fuel filter Filtre carburant	
07630			
  	4 057822 076306	000 993 0005 Feder Spring Ressort	















KTK No.		RF No.	Bezeichnung Description Désignation	Erläuterungen Remarks Remarques
07631	 4 057822 076313			
		000 997 0040	Scheibe Washer Rondelle	
07632	 4 057822 076320			
		000 091 0040	Schauglas Inspection bowl Verre de filtre	
07633	 4 057822 076337			
		000 091 0541 000 990 0357	Reparatursatz Bracket, repair kit Kit de réparation	L series SK/MK/NG series
07634	 4 057822 076344			
			Reparatursatz Repair kit Kit de réparation	L series SK/MK/NG series
07635	 4 057822 076351			
		000 477 0002 000 092 7901	Kraftstofffilter Fuel filter Filtre carburant Baumuster	L seires SK/MK/NG seires

KTK No.	RF No.	Bezeichnung Description Désignation	Erläuterungen Remarks Remarques
07640			
 4 057822 076405 1			
 	422 090 0252 001 477 5001	Kraftstofffilter Fuel filter Filtre carburant	L series SK/MK/NG series
07641			
 4 057822 076412 1			
 	000 477 3508	Filterdeckel Filter cover Dessus de filtre	L series SK/MK/NG series
08277			
 4 057822 082772 1			
 	000 074 1771	Schraube Screw Vis	L series SK/MK/NG series
07534			
 4 057822 075347 1			
 	000 477 3180	Dichtring Seal ring Bague d'étanchéité	L series SK/MK/NG series 95x103x3
07639			
 4 057822 076399 1			
 	000 477 3580	Wellendichtring Seal ring Joint d'étanchéité	75x81.4x3 L series SK/MK/NG series

KTK No.		RF No.	Bezeichnung Description Désignation	Erläuterungen Remarks Remarques
08367	 4 057822 083670			
	 	000 091 1101S	Handpumpe mit Feder Hand pump with spring Pompe á main , ressort	L series SK/MK/NG series
07619	 4 057822 076191			
	 	000 091 1101	Handpumpe Hand pump, steel Pompe á main	L series SK/MK/NG series
08366	 4 057822 083663			
	 	000 090 0050	Handpumpe Hand pump, aluminium Pompe á main	L series SK/MK/NG series
07622	 4 057822 076221			
	 	000 090 8850	Handpumpe Hand pump Pompe á main	L series SK/MK/NG series
08620	 4 057822 086206			
	 	000 091 2190	Handpumpe Hand pump Pompe á main	L series SK/MK/NG series

KTK No.		RF No.	Bezeichnung Description Désignation	Erläuterungen Remarks Remarques
07616	 4 057822 076160			
		000 090 0650	Förderpumpe Fuel Feed pump Pompe d'alimentation carburant	SK/MK/NG series
07615	 4 057822 076153			
		001 091 2501 000 090 0350	FÖrderpump Feed pump Pompe d'alimentation carburant	L series
07617	 4 057822 076177			
		000 090 3150	FÖrderpumpe Feed pump Pompe d'alimentation carburant	SK/MK/NG series
10083	 4 057822 100834			
		000 090 6050	Handpumpe Hand pump Pompe á main	ACTROS/AXOR SK/MK/NG series
10084	 4 057822 100841			
		000 090 0751	Reparatursatz Repair kit Kit de réparation	



KTK No.	RF No.	Bezeichnung Description Désignation	Erläuterungen Remarks Remarques
10086	 4 057822 100865		
		000 092 3303cpl Reparatursatz Repair kit Kit de réparation	
10085	 4 057822 100858		
		000 092 3303 Schauglas Bowl Verre de filtre	
10122	 4 057822 101220		
		003 091 4201 Handpumpe Hand pump Pompe à main	L series 422 / 442
10124	 4 057822 101244		
		000 090 3550 Handpumpe Hand pump Pompe à main	SK/MK/NG series
07530	 4 057822 075309		
		000 094 2580 Dichtung Gasket / Joint	L series L 1924

KTK No.	RF No.	Bezeichnung Description Désignation	Erläuterungen Remarks Remarques
07529			
 4 057822 075295			
	000 094 7980	Dichtung Gasket Joint	SK/MK/NG
21580			
 4 057822 215806			
	000 470 0469	Wasserabscheider Water separator Séparateur d'eau	

KTK No.	RF No.	Bezeichnung Description Désignation	Erläuterungen Remarks Remarques
---------	--------	---	---------------------------------------













20304



























004 091 0501  
003 091 7401









Kraftstoffpumpe  
Fuel pump  
Pompe à carburant

Actros/Ageto  
904/906

KTK No.	RF No.	Bezeichnung Description Désignation	Erläuterungen Remarks Remarques
<p><b>10938</b></p>  <p>4 057822 109387</p>			
 	<p>002 094 6382 001 094 7982 002 094 5482</p>	<p>Ladeluftschlauch Air hose Durite intercooler</p>	<p>L series AXOR ∅100mm</p>
<p><b>15138</b></p>  <p>4 057822 151386</p>			
 	<p>002 094 5782 002 094 0882 002 094 5582 002 094 6682</p>	<p>Ladeluftschlauch Air hose Durite intercooler</p>	<p>ACTROS ∅115mm</p>
<p><b>10939</b></p>  <p>4 057822 109394</p>			
 	<p>002 094 5282 002 094 5982</p>	<p>Ladeluftschlauch Air hose Durite d'air de charge</p>	<p>SK/MK/NG series ∅100mm</p>
<p><b>21939</b></p>  <p>4 057822 219394</p>			
 	<p>002 094 6982</p>	<p>Ladeluftschlauch Air hose Durite d'air de charge</p>	<p>Atego</p>

KTK No.	RF No.	Bezeichnung Description Désignation	Erläuterungen Remarks Remarques
15799	 4 057822 157999		
		645 528 0182 Ladeluftschlauch Air hose Durite d'air de charge	SK/MK/NG series 2635 / 2544 2638
07656	 4 057822 076566		
		361 528 0091 Manschette Rubber boot Manchon caoutchouc	L series
07523	 4 057822 075231		
		620 528 0782 000 094 9882 Manschette Rubber boot Manchon caoutchouc	SK/MK/NG series New version
21934	 4 057822 219345		
		941 528 0882 Ladeluftschlauch Air hose Durite d'air de charge	
21933	 4 057822 219338		
		624 528 0282 Ladeluftschlauch Air hose Durite d'air de charge	

KTK No.		RF No.	Bezeichnung Description Désignation	Erläuterungen Remarks Remarques
21913	 4 057822 219130 1			
		942 528 1282 942 528 0582	Schlauch, Öleinfüllstutzen Hose, oil filler connector Tuyau, goulotte de remplissage d'huile	Actros/Axor
22628	 4 057822 226282 1			
		011 997 7782	Kraftstoffschlauch Fuel hose Durite de carburant	SK/MK/NG series 25mtr. Per Roll 3.2x9
08178	 4 057822 081782 1			
		363 475 0220 404 475 0120	Gummiunterlage Rubber pad Sangle caoutchouc réservoir	25mtr. Per Roll L series SK/MK/NG series

KTK No.	RF No.	Bezeichnung Description Désignation	Erläuterungen Remarks Remarques
06563			
	 4 057822 065638  	352 993 1910 303 993 0610 322 993 0310  Feder / Spring / Ressort	L series
07637			
	 4 057822 076375  	442 993 5110 403 993 0510  Feder Spring Ressort	SK/MK/NG series
06555			
	 4 057822 065553  	403 993 0810  Feder Spring Ressort	SK/MK/NG series

KTK No.	RF No.	Bezeichnung Description Désignation	Erläuterungen Remarks Remarques
---------	--------	---	---------------------------------------

11776



000 471 1230  
302 471 01 30

Tankdeckel, belüftet  
Fuel tank cap  
Bouchon de réservoir, ventilé

L series  
302/328  
652/699















19912





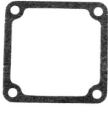











000 470 0405















Tankdeckel, belüftet  
Fuel tank cap  
Bouchon de réservoir, ventilé





















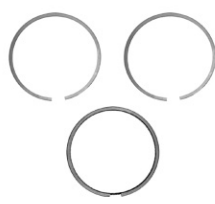











KTK No.		RF No.	Bezeichnung Description Désignation	Erläuterungen Remarks Remarques
07447	 4 057822 074470			
			Reparatursatz Repair kit Kit de réparation	L series OM 355 90mm
07662	 4 057822 076627			
		001 131 7280	Dichtung Gasket Joint	
07664	 4 057822 076641			
		000 131 2179	Dichtung Gasket Joint	
07663	 4 057822 076634			
		000 131 2079	Dichtung Gasket Joint	
07660	 4 057822 076603			
		009 997 7246	Wellendichtring Oil seal Bague d'etanchéité	













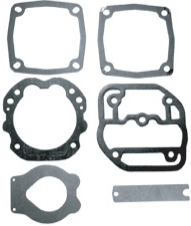

KTK No.		RF No.	Bezeichnung Description Désignation	Erläuterungen Remarks Remarques
07661	 4 057822 076610			
		000 131 4631	Dichtung Gasket Joint	
07658	 4 057822 076580			
		897 670 9004	O-Ring O-ring Joint torique	
07659	 4 057822 076597			
		000 131 3831	Scheibe Valve disc Disque	
07657	 4 057822 076573			
		897 670 1904	O-Ring O-ring Joint torique	
08640	 4 057822 086404			
			Ring 90mm $\varnothing$ Joint	











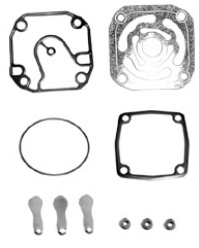

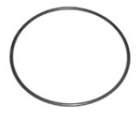
KTK No.	RF No.	Bezeichnung Description Désignation	Erläuterungen Remarks Remarques
<p>08641</p>  <p>4 057822 086411</p>  		<p>Reparatursatz mit ring Repair kit with ring Kit de réparation</p>	
<p>06710</p>  <p>4 057822 067106</p>  	<p>402 130 0220 402 130 0020 402 586 5013</p>	<p>Reparatursatz Repair kit Kit de réparation S</p>	<p>For 90mm water cooled liner K/MK/NG series</p>
<p>06927</p>  <p>4 057822 069278</p>  	<p>442 131 0780</p>	<p>Dichtung Gasket Joint</p>	
<p>06928</p>  <p>4 057822 069285</p>  	<p>442 131 0980</p>	<p>Dichtung Gasket Joint</p>	
<p>06495</p>  <p>4 057822 064952</p>  	<p>442 131 0080</p>	<p>Dichtung Gasket Joint</p>	

KTK No.		RF No.	Bezeichnung Description Désignation	Erläuterungen Remarks Remarques
08986	 4 057822 089868			
			O-Ring O-ring Joint torique	
08499	 4 057822 084998			
			Ring 90mm $\varnothing$ Joint	
08642	 4 057822 086428			
			Reparatursatz Repair kit Kit de réparation	
18962	 4 057822 189624			
		000 130 2619 000 130 2519	Head, Compressor	401/402/403 421/422/423
15103	 4 057822 151034			
		402 130 0320	Reparatursatz Repair kit Kit de réparation	For 90mm water cooled liner SK/MK/NG series











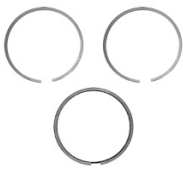

KTK No.	RF No.	Bezeichnung Description Désignation	Erläuterungen Remarks Remarques
15104	 4 057822 15104 1		
		402 130 0320/P Scheibe Valve plate Disque	
06510	 4 057822 06510 2		
		442 131 2280 442 131 2580 Reparatursatz Repair kit New version Kit de réparation	100 mm Air cooled SK/MK/NG OM 441, 442,
06945	 4 057822 06945 2		
		441 130 0220 Scheibe Valve disc kit Disque	
08500	 4 057822 08500 1		
		001 131 1511 Ring 100mm $\varnothing$ Joint	
08643	 4 057822 08643 5		
		Reparatursatz Repair kit with ring Kit de réparation	





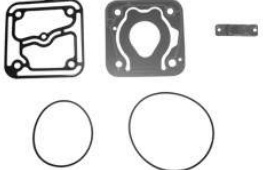

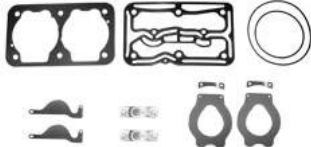



KTK No.	RF No.	Bezeichnung Description Désignation	Erläuterungen Remarks Remarques
18965	4 057822 189655		
	 	441 130 0120    Reparatursatz 441 130 0220    Head kit, Compressor 441 130 0020    Kit de réparation	SK/MK/NG
18970	4 057822 189709		
	 	442 131 0119    Zylinderkopf, Kompressor 442 130 3219    Cylinder head, compressor Culasse, compresseur	401/402 421/423 440 ... 447
07668	4 057822 076689		
	 	Reparatursatz Repair kit Jeu de réparation	OM 441 SK/MK/NG
07446	4 057822 074463		
	 	442 131 0180    Dichtung Gasket Joint	
18963	4 057822 189631		
	 	442 130 0720    Reparatursatz 442 130 0220    Head kit, Compressor Kit de réparation	SK/MK/NG



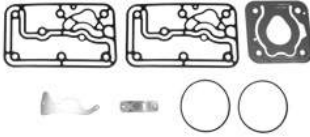

KTK No.		RF No.	Bezeichnung Description Désignation	Erläuterungen Remarks Remarques
18964	 4 057822 189648	  407 130 0519 407 130 0319 407 130 0419 407 130 0219	Zylinderkopf, Kompressor Cylinder head, compressor Culasse, compresseur	SK/MK/NG
08286	 4 057822 082864	 	Reparatursatz Repair kit Kit de réparation	SK/MK/NG
08499	 4 057822 084998	 	Ring 90mm $\varnothing$ Joint torique	
07665	 4 057822 076658	 	Reparatursatz Repair kit with ring Kit de réparation	
08285	 4 057822 082857	 	Reparatursatz Repair kit with ring Kit de réparation	SK/MK/NG

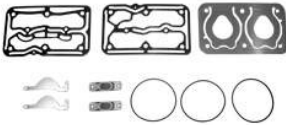





KTK No.	RF No.	Bezeichnung Description Désignation	Erläuterungen Remarks Remarques
<p>11102</p>  <p>4 057822 111021</p>  		<p>Reparatursatz Repair kit Kit de réparation</p>	<p>ACTROS/AXOR 521/541/542 941/942 100mm</p>
<p>10059</p>  <p>4 057822 100599</p>  	<p>005 997 1945</p>	<p>O-Ring O-ring Joint torique</p>	
<p>11100</p>  <p>4 057822 111007</p>  	<p>541 131 0680</p>	<p>Dichtung Gasket Joint</p>	
<p>11101</p>  <p>4 057822 111014</p>  	<p>541 131 0131</p>	<p>Dichtung Gasket Joint</p>	
<p>09834</p>  <p>4 057822 098346</p>  	<p>541 131 0780</p>	<p>Dichtung Gasket Joint</p>	

































KTK No.		RF No.	Bezeichnung Description Désignation	Erläuterungen Remarks Remarques
11248	 4 057822 112486			
		501 131 1511 001 131 1311	Ring 100mm $\varnothing$ / Joint	
16257	 4 057822 162573			
		541 130 0620	Reparatursatz Repair kit Kit de réparation	ACTROS 521 /541/542 941/942
18971	 4 057822 189716			
		541 131 0919 541 131 1019 541 131 1219	Zylinderkopf, Kompressor Cylinder head, compressor Culasse, compresseur	Actros
15351	 4 057822 153519			
		000 130 6815	Reparatursatz Repair kit Kit de réparation	AXOR ATEGO
15347	 4 057822 153472			
		000 130 6915 457 130 0415	Reparatursatz Repair kit Kit de réparation	AXOR 906/909/926 2 Cylinder

KTK No.	RF No.	Bezeichnung Description Désignation	Erläuterungen Remarks Remarques
15352			
  	<p>4 057822 153526</p> <p>000 130 7615 541 130 0820 541 130 2719</p>	<p>Reparatursatz Repair kit Kit de réparation</p>	<p>ACTROS 541/542/942</p>
16258			
  	<p>4 057822 162580</p> <p>541 130 0820</p>	<p>Reparatursatz Repair kit Kit de réparation</p>	<p>ACTROS 541/542/942</p>
15349			
  	<p>4 057822 153496</p> <p>001 130 1215 001 130 2615 001 130 5219</p>	<p>Reparatursatz Repair kit Kit de réparation</p>	<p>AXOR Single Cylinder 460/457</p>
15348			
  	<p>4 057822 153489</p> <p>001 130 2815 001 130 2715 001 130 0815</p>	<p>Reparatursatz Repair kit Kit de réparation</p>	<p>AXOR ACTROS 460 / 457</p>













KTK No.		RF No.	Bezeichnung Description Désignation	Erläuterungen Remarks Remarques
10276	 4 057822 102760	442 130 0008 403 130 0117 442 130 0002	Kolben-Laufbuchsensatz Piston with liner Kit piston et chemise	Air type 90mm SK/MK/NG series
10275	 4 057822 102753	402 130 0308 402 130 0608	Kolben-Laufbuchsensatz Piston with liner Kit piston et chemise	Water type 90mm SK/MK/NG series
10277	 4 057822 102777	441 130 0008	Kolben-Laufbuchsensatz Piston with liner Kit piston et chemise	Air type 100mm SK/MK/NG series
10941	 4 057822 109417	541 130 0008	Kolben-Laufbuchsensatz Piston with liner Kit piston et chemise	Air type 100mm ACTROS

KTK No.		RF No.	Bezeichnung Description Désignation	Erläuterungen Remarks Remarques
18597	 4 057822 185978	000 130 3417 911 501 6242	Piston 85MM	STD
18598	 4 057822 185985	 	Piston 85MM	t0.10
18599	 4 057822 185992	 	Piston 85MM	0.20

KTK No.		RF No.	Bezeichnung Description Désignation	Erläuterungen Remarks Remarques
09038	 4 057822 090388			
		442 141 0980	Dichtung Gasket / Joint	SK/MK/NG series
06473	 4 057822 064730			
		422 142 0080	Reparatursatz Repair kit Kit de réparation	SK/NG series
06467	 4 057822 064679			
		442 187 0080	Dichtung Gasket / Joint	
07651	 4 057822 076511			
		442 187 0180	Dichtung Gasket / Joint	
06472	 4 057822 064723			
		422 144 0280	Dichtung Gasket / Joint	













KTK No.	RF No.	Bezeichnung Description Désignation	Erläuterungen Remarks Remarques
06471	 4 057822 06471 6		
		422 142 0080cpl Reparaturatz Repair kit Kit de réparation	
06509	 4 057822 06509 6		
		355 142 0180 Reparaturatz Repair kit Kit de réparation	L series
07643	 4 057822 07643 6		
		447 187 0080 Dichtung Gasket / Joint	
07644	 4 057822 07644 3		
		407 187 0180 Dichtung Gasket / Joint	
06481	 4 057822 06481 5		
		427 144 0180 Dichtung Gasket / Joint	





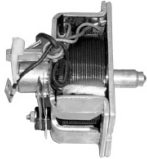









KTK No.	RF No.	Bezeichnung Description Désignation	Erläuterungen Remarks Remarques
06480	 4 057822 064808		
		355 142 0180 Cpl.	Reparatursatz Repair kit Kit de réparation
09010	 4 057822 090104		
		403 142 0212 423 142 0212	Klemmstück Spacer / Agrafe
ACTROS/AXOR SK/MK/NG			







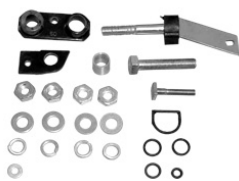







KTK No.		RF No.	Bezeichnung Description Désignation	Erläuterungen Remarks Remarques
11104	 4 057822 111045			
		346 990 0719	Schraube Bolt exhaust manifold Vis	L series 69mm M12x1.75
08012	 4 057822 080129			
		447 990 5204 447 990 7004	Schraube Bolt / Vis	70mm SK/MK/NG
08817	 4 057822 088170			
		447 990 5404 447 990 6004 447 990 6704	Schraube Bolt / Vis	L = 85mm SK/MK/NG
08816	 4 057822 088163			
		447 990 7104	Schraube Bolt / Vis	L = 106mm SK/MK/NG











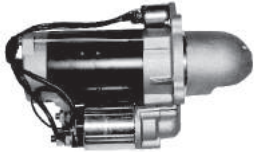



















KTK No.	RF No.	Bezeichnung Description Désignation	Erläuterungen Remarks Remarques
18518	 4 057822 185183		
  	541 140 2203 541 140 1303 541 140 0803	Abgaskrümmter Exhaust Pipe Collecteur d'échappement	Actros
18519	 4 057822 185190		
  	541 140 2503 541 140 1503 541 140 1903	Abgaskrümmter Exhaust Pipe Collecteur d'échappement	Actros













KTK No.	RF No.	Bezeichnung Description Désignation	Erläuterungen Remarks Remarques
10833	 4 057822 108335		
		000 151 0633 Reparatursatz Repair kit Kit de réparation	1987 010 000 SK/MK/NG series
10834	 4 057822 108342		
		000 151 0633 Lamellenkupplung Starter clutch Embrayage multi-disque	SK/MK/NG series
10835	 4 057822 108359		
		000 152 4010 001 152 9010 Magnetschalter Solenoid switch Electrovalve	ACTROS/541/42 SK/MK/NG series L series
10836			
		000 152 4210 Magnetschalter Solenoid switch Electrovalve	ACTROS/541/42 SK/MK/NG series L series
10837	 4 057822 108373		
		000 151 4050 Buchse Bushing / Bague	SK/MK/NG series L series

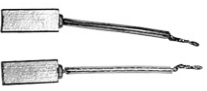











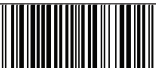

KTK No.	RF No.	Bezeichnung Description Désignation	Erläuterungen Remarks Remarques
10838	 4 057822 108380		
		000 151 4150	Buchse Bushing / Bague  SK/MK/NG series L series
10839	 4 057822 108397		
		000 151 7614 000 151 8914 000 151 3214	Kohlebürstensatz Carbon brush set Balai d'alternateur  ACTROS 541/42 SK/MK/NG seires
10840	 4 057822 108403		
		000 151 4015	Anker Armature / Induit  SK/MK/NG series 24V, 5.4KW Small
10842	 4 057822 108427		
		000 151 3915	Anker Armature / Induit  L series 24V Big
10843	 4 057822 108434		
			Reparatursatz Repair kit Kit de réparation

KTK No.		RF No.	Bezeichnung Description Désignation	Erläuterungen Remarks Remarques
10844	 4 057822 108441			
		000 151 7055	Feldwicklung Filed winding Bobine inductrice	L series SK/MK/NG series
10846	 4 057822 108465			
		001 152 3010	Magnetschalter Solenoid switch Electrovalve	12 V SK/MK/NG series
10847	 4 057822 108472			
			Magnetschalter Solenoid switch Electrovalve SK/MK/NG series	12V 0331 402 015
10851	 4 057822 108519			
		003 151 4101 003 151 4501 003 151 6001	Anlasser Starter motor Démarreur	24V / 5.4KW SK/MK/NG series
21551	 4 057822 215514			
		007 151 0201 007 151 0401 006 151 6901 006 151 1501	Anlasser Starter motor Démarreur	Actros/Axor





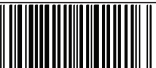





KTK No.	RF No.	Bezeichnung Description Désignation	Erläuterungen Remarks Remarques	
21549				
	006 151 2203 006 151 2201 005 151 2201 005 151 2001	Anlasser Starter motor Démarreur	Actros/Atego	
14208	 4 057822 142087 1	 	004 151 8801 004 151 9401 Anlasser Starter motor Démarreur	24V / 6.2KW ACTROS/AXOR Battery connection pin backside
14209	 4 057822 142094 1	 	000 150 6015 Anker Armature Induit	24V / 6.2KW ACTROS/AXOR
14210	 4 057822 142100 1	 	001 152 3210 Magnetschalter Solenoid switch Electrovalve	ACTROS/AXOR 457 521/541/542 941/942
14211	 4 057822 142117 1	 	000 151 9655 Feldwicklung Filed winding Bobine inductrice	ACTROS/AXOR 457 521/541/542 941/942

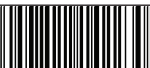













KTK No.	RF No.	Bezeichnung Description Désignation	Erläuterungen Remarks Remarques
14212			
 4 057822 142124			
  	000 150 1031	Anlasserritzel Starter pinion Pignon démarreur	ACTROS/AXOR 457 541/542 941
14213			
 4 057822 142131			
  	005 151 5001	Anlasser Starter motor Démarreur	ACTROS/AXOR 457 541/542 941 24V / 6.2KW
14214			
 4 057822 142148			
  	001 152 6310	Magnetschalter Solenoid switch Electrovalve	ACTROS
14218			
 4 057822 142186			
  	000 152 9310	Magnetschalter Solenoid switch Electrovalve	OM 616
10848			
 4 057822 108489			
  	000 154 1705	Regler Regulator Régulateur	SK/MK/NG series















KTK No.		RF No.	Bezeichnung Description Désignation	Erläuterungen Remarks Remarques
11522	 4 057822 115227			
		000 154 5414 000 154 0114 000 154 4414	Kohlebürstensatz Carbon brush set Balai d'alternateur	SK/MK/NG 352/615/616
11523	 4 057822 115234			
		000 154 7114	Kohlebürstensatz Carbon brush set Balai d'alternateur	L series SK/MK/NG
14220	 4 057822 142209			
		000 151 7914	Kohlebürstensatz Carbon brush set Balai d'alternateur	L series
22421	 4 057822 224219			
			Regler Regulator Régulateur	SK/MK/NG series

KTK No.		RF No.	Bezeichnung Description Désignation	Erläuterungen Remarks Remarques
10849	 4 057822 108496			
		005 154 5102 005 154 8302	Generator Alternator Générateur	28V / 27A LK SK/MK/NG series
10850	 4 057822 108502			
		009 154 0702 007 154 2702	Generator Alternator Générateur	24V / 55A SK/MK/NG series
22108	 4 057822 221089			
		009 154 1502	Generator Alternator Générateur	
21550	 4 057822 221089			
		012 154 6802 013 154 7802 014 154 5302	Generator Alternator Générateur	Actros
14221	 4 057822 142216			
		012 154 0402 013 154 2902	Generator Alternator Générateur	24V / 80A ACTROS/AXOR 457/541/542





















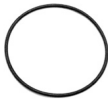

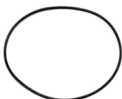
KTK No.		RF No.	Bezeichnung Description Désignation	Erläuterungen Remarks Remarques
14222	 4 057822 142223			
		000 154 2705 000 154 3805	Regler Régulateur Régulateur	ACTROS/AXOR
14223	 4 057822 142230			
		001 154 3616	Regler Régulateur / Régulateur	ACTROS/AXOR L series
07525	 4 057822 075255			
		403 155 0250	Buchse Bushing / Bague	L series SK/MK/NG 24x10x25
10351	 4 057822 103514			
		403 150 0572 314 150 1272	Reparatursatz Repair kit Kit de réparation	SK/MK/NG series L series





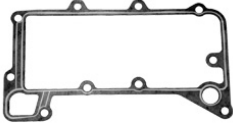







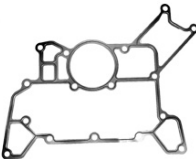

KTK No.		RF No.	Bezeichnung Description Désignation	Erläuterungen Remarks Remarques
19810	 4 057822 198107			
  		000 153 9932	Öl drucksensor Oil pressure sensor Capteur de pression d'huile	Actros/Axor Atego
19819	 4 057822 198190			
 With IC 		004 153 1828 004 153 1928	Ladedrucksensor Charge pressure sensor Capteur de pression de suralimentation	Actros/Axor/ Atego
19820	 4 057822 198206			
 Without IC 		004 153 7028	Ladedrucksensor Charge pressure sensor Capteur de pression de suralimentation	Actros/Axor/ Atego
21067	 4 057822 210670			
		001 153 2120	Drehzahlsensor Rotation sensor Capteur de vitesse de rotation	Actros













KTK No.	RF No.	Bezeichnung Description Désignation	Erläuterungen Remarks Remarques
07669			
 4 057822 076696			
 	355 180 1265 345 180 7065 356 180 0065	Ölkühler Oil cooler Refroidisseur d'huile	LK/MK/NG 5 Ribs
09614			
 4 057822 096144			
 	355 180 1165 345 180 7165	Ölkühler Oil cooler Refroidisseur d'huile	OM355 A 6 Ribs LK/MK/NG series
07670			
 4 057822 076702			
 	001 188 3101 000 188 6401 000 188 1101	Ölkühler Oil cooler Refroidisseur d'huile	SK/MK/NG Ribs : 10
07671			
 4 057822 076719			
 	002 188 4301 002 188 1801	Ölkühler Oil cooler Refroidisseur d'huile	AXOR 457 SK/MK/NG Ribs : 13
07672			
 4 057822 076726			
 	001 188 8901 001 188 8801	Ölkühler Oil cooler Refroidisseur d'huile	SK/MK/NG Ribs: 10

KTK No.	RF No.	Bezeichnung Description Désignation	Erläuterungen Remarks Remarques
15819			
 4 057822 158194			
	541 188 0201	Ölkühler Oil cooler Refroidisseur d'huile	ACTROS 521/522 541/542 941/942 Ribs: 12
			















KTK No.	RF No.	Bezeichnung Description Désignation	Erläuterungen Remarks Remarques
13225			
	 4 057822 132255	403 180 3938  Ölkühlergehäuse Oil cooler housing Carter de refroidisseur d'huile	SK/MK/NG
13226			
	 4 057822 133269	403 180 2438  Ölkühlergehäuse Oil cooler housing Carter de refroidisseur d'huile	SK/MK/NG
13227			
	 4 057822 132279	442 188 1604  Ölkühlergehäuse Oil cooler housing Carter de refroidisseur d'huile	SK/MK/NG
13228			
	 4 057822 132286	541 188 1204 541 188 2204  Ölkühlergehäuse Oil cooler housing Carter de refroidisseur d'huile	ACTROS

KTK No.	RF No.	Bezeichnung Description Désignation	Erläuterungen Remarks Remarques
07673			
 4 057822 076733			
 	000 184 6580 009 997 1545	O-Ring O-ring / Joint torique	LP/NG 115mm
07537			
 4 057822 075378			
 	008 997 7045	O-Ring O-ring / Joint torique	ACTROS/AXOR SK/MK/NG series 134mm
06499			
 4 057822 064990			
 	355 184 0480 355 184 0780	Dichtung Gasket / Joint	L series
06489			
 4 057822 064891			
 	442 188 0580 403 184 0280 442 188 0280	Dichtung Gasket / Joint	AXOR 457 SK/MK/NG series
06498			
 4 057822 064983			
 	442 184 0580 403 184 0380	Dichtung Gasket / Joint	NG series 401/402/403 407/409

KTK No.	RF No.	Bezeichnung Description Désignation	Erläuterungen Remarks Remarques
06469	 4 057822 064693		
		917 003 026 003 917 003 026 000 Dichtung Gasket / Joint	SK/MK/NG series ⌀ 26mm
09829	 4 057822 098292		
		541 184 0780 541 184 0580 541 184 0680 541 184 0980 Dichtung Gasket / Joint	ACTROS/AXOR
09836	 4 057822 098360		
		541 188 0080 Dichtung Gasket / Joint	ACTROS
13324			
		422 180 0315 Überströmventil Overflow valve Valve de sécurité	ACTROS/AXOR MK/SK/NG
13363	 4 057822 133634		
		000 018 3835 403 010 0062 423 010 0162 Ölabscheider Oil separator Séparateur d'huile	SK/MK/NG

KTK No.		RF No.	Bezeichnung Description Désignation	Erläuterungen Remarks Remarques
13364	 4 057822 133641			
		000 018 3735 423 010 0062	Ölabscheider Oil separator Séparateur d'huile	SK/MK/NG
06943	 4 057822 069438			
		000 997 5348	O-Ring O-ring / Joint torique	SK/MK/NG 36.5x49.2x3.2
21900	 4 057822 219000			
		403 018 1182	Schlauch, Ölabscheider Hose, oil separator Tuyau, séparateur d'huile	402/403
23737	 4 057822 237370			
		457 188 0280	Gasket, oil cooler	AXOR



KTK No.	RF No.	Bezeichnung Description Désignation	Erläuterungen Remarks Remarques
11042			
  <p>4 057822 110420</p> 	355 180 0101	Ölpumpe Oil pump Pompe à huile	L series Ordinary
11043			
  <p>4 057822 110437</p> 	355 180 1601 345 180 74 01	Ölpumpe Oil pump Pompe à huile	L series Turbo
11044			
  <p>4 057822 110444</p> 	403 180 1701 401 180 0101 403 180 0601	Ölpumpe Oil pump / Pompe à huile	SK/MK/NG
11045			
  <p>4 057822 110451</p> 	423 180 0501 423 180 0101	Ölpumpe Oil pump / Pompe à huile	SK/MK/NG
11046			
  <p>4 057822 110468</p> 	541 180 0201 541 180 0101 541 180 0001	Ölpumpe Oil pump Pompe à huile	ACTROS

KTK No.	RF No.	Bezeichnung Description Désignation	Erläuterungen Remarks Remarques
---------	--------	---	---------------------------------------

11047



4 057822 110475



542 180 0101

Ölpumpe















ACTROS















542 180 0201















Oil pump















542 180 0001

Pompe à huile

KTK No.	RF No.	Bezeichnung Description Désignation	Erläuterungen Remarks Remarques
11035			
	 <p>4 057822 110352</p> 	<p>355 200 1501 355 200 1101</p> <p>Wasserpumpe Water pump Pompe à eau</p>	<p>L series</p>
08117			
	 <p>4 057822 081171</p> 	<p>356 201 0180 355 201 0680</p> <p>Dichtung Gasket / Joint</p>	
12093			
	 <p>4 057822 120931</p> 	<p>355 200 1204</p> <p>Reparatursatz Repair kit Kit de réparation</p>	
12094			
	 <p>4 057822 120948</p> 	<p>355 200 1401</p> <p>Reparatursatz Repair kit Kit de réparation</p>	
06500			
	 <p>4 057822 065003</p> 	<p>355 203 0080 355 203 0180</p> <p>Dichtung Gasket / Joint</p>	<p>L series</p>

KTK No.	RF No.	Bezeichnung Description Désignation	Erläuterungen Remarks Remarques
06468	 4 057822 064686		
		326 997 0149 355 997 0049 Dichtung Gasket / Joint	L series
11036	 4 057822 110369		
		403 200 4901 403 200 3501 403 200 7001 Wasserpumpe Water pump Pompe à eau	NG series
08116	 4 057822 110369		
		403 201 1080 Dichtung Gasket / Joint	SK/MK/NG
12095	 4 057822 120955		
		403 200 6901 Reparatursatz Repair kit Kit de réparation	SK/MK/NG
11037	 4 057822 110376		
		403 200 7901 403 200 0260 Wasserpumpe Water pump Pompe à eau	SK/NG

KTK No.	RF No.	Bezeichnung Description Désignation	Erläuterungen Remarks Remarques
11038	 4 057822 110383		
		422 200 1201 422 200 0701 Wasserpumpe Water pump Pompe à eau	SK/MK/NG
18890	 4 057822 188900		
		422 200 1101 422 200 0601 422 200 1601 457 201 0101 Wasserpumpe Water pump Pompe à eau	422
11050	 4 057822 110505		
		423 200 0104 422 200 0604 423 200 0004 Reparatursatz Repair kit Kit de réparation	SK/MK/NG
11039	 4 057822 110390		
		542 200 2001 542 200 0601 542 200 1601 Wasserpumpe Water pump Pompe à eau	ACTROS
09691	 4 057822 096915		
		542 201 0180 542 201 0080 Dichtung Gasket / Joint	ACTROS

KTK No.		RF No.	Bezeichnung Description Désignation	Erläuterungen Remarks Remarques
12096	 4 057822 120962			
		542 200 0104	Reparaturatz Repair kit Kit de réparation	ACTROS
12097	 4 057822 120979			
		542 200 0701	Reparaturatz Repair kit Kit de réparation	ACTROS
09830	 4 057822 098308			
		942 501 0080	Dichtung Gasket / Joint	ACTROS
11040	 4 057822 110406			
		541 200 1201 541 200 1101	Wasserpumpe Water pump Pompe à eau	ACTROS
11041	 4 057822 110413			
		542 200 1901 542 200 0501	Wasserpumpe Water pump Pompe à eau	ACTROS

KTK No.	RF No.	Bezeichnung Description Désignation	Erläuterungen Remarks Remarques
---------	--------	---	---------------------------------------

20383



541 201 0180

Dichtung  
Gasket / Joint















ACTROS

20380



















403 201 1631  
442 201 0531















Auslaufstutzen, Wasserpumpe 401/421  
Outlet, water pump  
Tubulure de sortie, pompe à eau













KTK No.		RF No.	Bezeichnung Description Désignation	Erläuterungen Remarks Remarques
07674	 4 057822 076740			
		003 203 7975	Thermostatsatz Thermostat Kit de thermostat	71 C SK/MK/NG
09026	 4 057822 090265			
			Thermostatsatz Thermostat Kit de thermostat	65 C
07675	 4 057822 076757			
			Thermostatsatz Thermostat Kit de thermostat	60 C
14204	 4 057822 142049			
			Thermostatsatz Thermostat Kit de thermostat	83 C
07676	 4 057822 076764			
		003 997 5748 020 997 1148	O-Ring O-ring / Joint torique	

















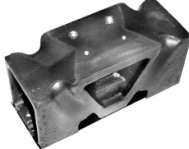













KTK No.		RF No.	Bezeichnung Description Désignation	Erläuterungen Remarks Remarques
13218	 4 057822 132187			
		002 205 7006	Lufter Fan Ventilateur	620x127mm SK/MK/NG 407/466/492 496
10217	 4 057822 102173			
		403 200 0926	Nabe, Lüfter Fan hub Moyeu, ventilateur	SK/MK/NG
13215	 4 057822 132156			
		003 205 0106	Lufter Fan Ventilateur	750x180mm ACTROS 541/542 941/942
13216	 4 057822 132163			
		003 205 0006	Lufter Fan Ventilateur	720x180mm SK/MK/NG 397 402/440//441 442/445/446
13217	 4 057822 132170			
		003 205 3606	Lufter Fan Ventilateur	705x127mm ACTROS/AXOR 541/542 457





KTK No.	RF No.	Bezeichnung Description Désignation	Erläuterungen Remarks Remarques	
13219	 4 057822 132194			
		002 205 0306 002 205 9306	Lufter Fan Ventilateur	680x127mm SK/NG 475/476 482/625
19228	 4 057822 192280			
		906 205 0406	Lufter Fan Ventilateur	700x90x155 ACTROS/AXOR















KTK No.		RF No.	Bezeichnung Description Désignation	Erläuterungen Remarks Remarques
16380	 4 057822 163808			
		457 200 1470 457 200 0270 457 200 2270	Riemenspanner Belt tensioner Tendeur de courroie	AXOR 457 902/904/906 907/906/924 926
16384	 4 057822 163846			
		906 200 0270 906 200 1470 906 200 1770 906 200 2070	Riemenspanner Belt tensioner Tendeur de courroie	ATEGO 357/457 904/906/907 909/924/926
16385	 4 057822 163853			
		906 200 1270 906 200 0370	Riemenspanner Belt tensioner Tendeur de courroie	ATEGO/AXOR 902/904/906/ 907/909/924/926
16398	 4 057822 163983			
		000 550 1633 000 550 0833	Spannrolle Tension roller galet tendeur	ACTROS ATEGO AXOR
16395	 4 057822 163952			
		541 200 1870 541 200 2470	Riemenspanner Belt tensioner Tendeur de courroie	ACTROS 80x48

KTK No.		RF No.	Bezeichnung Description Désignation	Erläuterungen Remarks Remarques
16396	 4 057822 163969			
		541 200 1170	Riemenspanner Belt tensioner Tendeur de courroie	ACTROS 80x45
16386	 4 057822 163860			
		541 200 1670 541 200 0470	Riemenspanner Belt tensioner Tendeur de courroie	ACTROS 74x46x67
16397	 4 057822 163976			
		541 200 1570	Riemenspanner Belt tensioner Tendeur de courroie	ACTROS 74x34x61
21505	 4 057822 163976			
		457 200 1970	Riemenspanner Belt tensioner Tendeur de courroie	Axor















KTK No.	RF No.	Bezeichnung Description Désignation	Erläuterungen Remarks Remarques
09748			
 4 057822 097486			
 	000 241 0513 000 241 0413	Gummilager Rubber Mounting Silentbloc Small	L series Front
09750			
 4 057822 097509			
 	343 241 0013	Gummilager Rubber Mounting Silentbloc	L series Front Big
09749			
 4 057822 097493			
 	000 242 1213 350 240 7018	Gummilager Rubber Mounting Support en caoutchouc	L series Rear
09751			
 4 057822 097516			
 	645 240 0418 645 240 0518 620 240 0018	Gummilager Rubber Mounting Silentbloc	18MM Rear ACTROS SK/MK/NG
09753			
 4 057822 097530			
 	617 240 0318 645 240 0218 387 240 0218	Gummilager Rubber Mounting Support en caoutchouc	16MM / Rear L series SK/MK/NG

KTK No.	RF No.	Bezeichnung Description Désignation	Erläuterungen Remarks Remarques
07677	 4 057822 076771		
		000 960 018 148    Schraube Bolt / Vis	18x70 OM 442, 443
07933	 4 057822 079338		
		000 960 016 249    Schraube Bolt / Vis	16x60 OM 402, 403 422
09756	 4 057822 097561		
		620 240 0717    Gummilager 620 240 0217    Mounting 620 240 0017    Silentbloc	Front NG
09757	 4 057822 097578		
		658 241 0013    Gummilager 620 240 04 17    Mounting 620 240 0317    Silentbloc	16MM Aluminium NG/SK
15483	 4 057822 154837		
		387 240 0017    Gummilager 387 240 0317    Rubber mounting Silentbloc	Steel type SK/MK/NG

KTK No.	RF No.	Bezeichnung Description Désignation	Erläuterungen Remarks Remarques
09755	 4 057822 097554	941 241 5713 Gummilager 941 241 1713 Rubber mounting 941 241 4713 Silentbloc	ACTROS
11168	 4 057822 111687	655 241 0713 Gummilager 655 241 0113 Mounting Silentbloc	Front right SK series
11169	 4 057822 111694	655 241 0613 Gummilager 655 241 1113 Mounting Silentbloc	Front left SK series
23130	 4 057822 231309	941 241 8713 Gummilager Mounting Silentbloc	
22791	 4 057822 227913	652 241 0213 Gummilager Mounting Silentbloc	

KTK No.		RF No.	Bezeichnung Description Désignation	Erläuterungen Remarks Remarques
11434	 4 057822 114343			
		655 250 0069cpl	Reparatursatz Repair kit Kit de réparation	SK/MK/NG series
08920	 4 057822 089207			
		650 254 0474	Bolzen, Kupplungshebel Pin, clutch lever Boulon, Levier d'embrayage	
11433	 4 057822 114336			
		007 993 012 100	Ring Torique	
08921	 4 057822 089214			
		655 250 0069	Buchse Bushing Bague	
12072	 4 057822 120726			
		385 997 0582 335 573 0036	Schlauch Clutch hose Durite	L series SK/MK/NG



KTK No.	RF No.	Bezeichnung Description Désignation	Erläuterungen Remarks Remarques
<p data-bbox="280 197 360 230">09673</p>  <p data-bbox="523 264 691 286">4 057822 096731</p>  	<p data-bbox="751 344 935 378">655 254 0206A</p>	<p data-bbox="995 344 1166 456">Reparaturatz Repair kit Kit de réparatio</p>	<p data-bbox="1299 344 1398 416">ACTROS 541</p>
<p data-bbox="280 577 360 611">09670</p>  <p data-bbox="523 633 691 656">4 057822 096700</p>  	<p data-bbox="751 703 916 736">002 992 1501</p>	<p data-bbox="995 703 1083 815">Buchse Bushing Bague</p>	
<p data-bbox="280 969 360 1003">09669</p>  <p data-bbox="523 1025 691 1048">4 057822 096694</p>  	<p data-bbox="751 1106 956 1140">000 988 036 100</p>	<p data-bbox="995 1106 1091 1218">Scheibe Washer Rondelle</p>	
<p data-bbox="280 1361 360 1395">09668</p>  <p data-bbox="523 1417 691 1440">4 057822 096687</p>  	<p data-bbox="751 1503 956 1536">912 009 035 100</p>	<p data-bbox="995 1503 1083 1574">Ring Torique</p>	
<p data-bbox="280 1753 360 1787">09671</p>  <p data-bbox="523 1809 691 1832">4 057822 096717</p>  	<p data-bbox="751 1890 919 1924">655 254 0206</p>	<p data-bbox="995 1890 1075 2002">Bolzen Shaft Boulon</p>	

<b>KTK No.</b>	<b>RF No.</b>	<b>Bezeichnung Description Désignation</b>	<b>Erläuterungen Remarks Remarques</b>
----------------	---------------	--	--

09672

































4 057822 096724



























304 017 012 011    Schraube  
Bolt  
Vis





















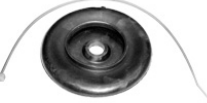

KTK No.		RF No.	Bezeichnung Description Désignation	Erläuterungen Remarks Remarques
11023	 4 057822 110239			
		000 250 4215 000 250 9115	Ausrücklager Release bearing Butée d'embrayage	LP LK/NG
11025	 4 057822 110253			
		320 250 0015 343 254 0010	Ausrücklager Release bearing Butée d'embrayage	L series
11031	 4 057822 110314			
		000 250 9215	Ausrücklager Release bearing Butée d'embrayage	SK/MK series 401 440/441/442 445/446
11026	 4 057822 110260			
		340 250 0215 352 250 0115 312 250 1315	Ausrücklager Release bearing Butée d'embrayage	L series
11021	 4 057822 110215			
		000 250 1915 000 250 2515	Ausrücklager Release bearing Butée d'embrayage	SK/NG

KTK No.	RF No.	Bezeichnung Description Désignation	Erläuterungen Remarks Remarques
11029	 4 057822 110291		
 	000 250 7515	Ausrücklager Release bearing Butée d'embrayage	SK/NG
11022	 4 057822 110222		
 	000 250 6415	Ausrücklager Release bearing Butée d'embrayage	SK/NG
11030	 4 057822 110307		
 	000 250 7315	Ausrücklager Release bearing Butée d'embrayage	MK/NG
11018	 4 057822 110185		
 	001 250 4815 001 250 0515 001 250 6415 001 250 6515 001 250 7915	Ausrücklager Release bearing Butée d'embrayage	MK/SK
11032	 4 057822 110321		
 	001 250 0615 001 250 8815 001 250 8015	Ausrücklager Release bearing Butée d'embrayage	SK series















KTK No.	RF No.	Bezeichnung Description Désignation	Erläuterungen Remarks Remarques
15364			
  4 057822 153649 	000 252 0643 000 252 0346	Ausrückring Release ring Bague de débrayage	SK/MK/NG
15363			
  4 057822 153632 	000 252 0646	Ausrückring Release ring Bague de débrayage	SK/MK/NG
11033			
  4 057822 110338 	001 250 4715 001 250 0915 001 250 6215	Ausrücklager Release bearing Butée d'embrayage	MK/SK
11020			
  4 057822 110208 	002 250 3715 002 250 4715	Ausrücklager Release bearing Butée d'embrayage	AXOR/ACTROS
15368			
  4 057822 153680 		Reparatursatz Repair kit Kit de réparation	ACTROS









KTK No.	RF No.	Bezeichnung Description Désignation	Erläuterungen Remarks Remarques
16135			
 4 057822 161354			
 	002 250 3015 002 250 5215 002 250 6215 002 250 7215 002 250 7615	Ausrücklager Release bearing Butée d'embrayage	ATEGO/AXOR 712/715 900/902 904/906 With sensor
16136			
 4 057822 161361			
 	002 250 5515 002 250 7315	Ausrücklager Release bearing Butée d'embrayage	ATEGO 712/715 900/902 904/906 Without sensor
22102			
 4 057822 221027			
 	002 250 4015 002 250 6815 002 250 7715 002 250 8215 002 250 9915	Ausrücklager Release bearing Butée d'embrayage	Atego/Actros













KTK No.	RF No.	Bezeichnung Description Désignation	Erläuterungen Remarks Remarques
07678	 4 057822 076788		620 260 0040 Schaltknauf ACTROS/AXOR 620 267 0010 Gear shift knob ATEGO 620 268 0142 Pommeau de levier de vitesses
07680	 4 057822 076801		620 268 0157 Abdeckung ATEGO/ACTROS Cover Couvercle
23045	 4 057822 230456		943 260 0209 Schaltknauf Gear shift knob Pommeau de levier de vitesses







KTK No.	RF No.	Bezeichnung Description Désignation	Erläuterungen Remarks Remarques	
07681	 4 057822 076818	620 268 0097	Manschette Boot, Gear shift lever Manchon	SK/MK/NG
				
07682	 4 057822 076825		Manschette Boot, Gear shift lever Manchon	OM346
				
09763	 4 057822 079635	000 260 0296	Reparatursat Repair kit Kit de réparation	OM 355 924, 2624 L series / NG/SK
				
14202	 4 057822 142023	000 267 0514 000 267 0214	Reparatursat Repair kit (Boot with Bush) Kit de réparation	OM 355 L series
				
09754	 4 057822 097548	361 266 0184 361 266 0084	Gummilager Rubber Mounting Silentbloc	L series Rear
				





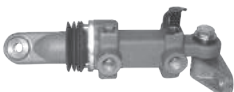











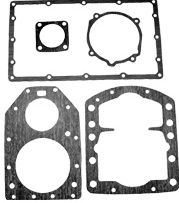









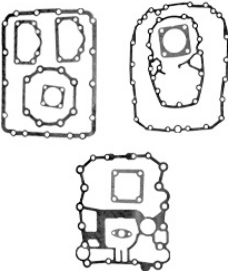

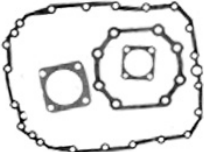

KTK No.	RF No.	Bezeichnung Description Désignation	Erläuterungen Remarks Remarques	
14303	 4 057822 143039			
		655 268 0074	Reparatursatz Repair kit Kit de reparation	SK/MK/NG
11105	 4 057822 111052			
		385 268 1474	Reparatursatz Repair kit Kit de reparation	SK/MK/NG
07524	 4 057822 075248			
		620 268 0196 385 268 0696	Manschette Boot Manchon	
07932	 4 057822 079322			
		000 933 012 069	Schraube Bolt for GB flange Vis	L series SK/MK/NG
06940	 4 057822 069405			
		343 263 0062	Dichtung Shim Joint	L series SK/MK/NG AK 6-80



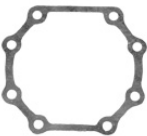









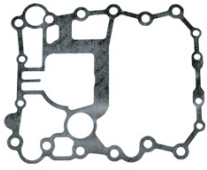

KTK No.	RF No.	Bezeichnung Description Désignation	Erläuterungen Remarks Remarques
19431	 4 057822 194314	 001 260 6357    Schalthebelventil    SK/MK/NG 001 260 2457    Gear shift lever valve 001 260 2557    Valve de levier de vitesses 001 260 5357 001 260 6457 001 260 9557	
19448	 4 057822 194482	 941 540 0545    Schalter, Schalthebel    Actros/Atego 003 545 4707    Switch, gear shift lever    Axor 941 540 0044    Interrupteur, levier de vitesses	
10914	 	001 260 6757    Ventil    SK/MK/NG 001 260 6257    Valve Soupape	
11111	 	000 260 6957    Ventil    L series 001 260 0257    Valve / Soupape    SK/MK/NG 001 260 0057                               717/718/719 000 260 6857	

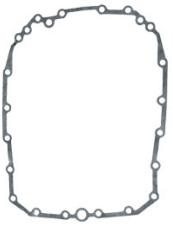







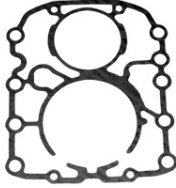

KTK No.	RF No.	Bezeichnung Description Désignation	Erläuterungen Remarks Remarques
19716	 4 057822 197162		
		000 260 4298	Schaltgerät Shift mechanism, gear Appareil commande
19717	 4 057822 197179		
		000 260 5998	Schaltgerät Shift mechanism, gear Appareil commande  Actros/Axor
19449	 4 057822 194499		
		000 260 4098 000 260 7198	Schaltgerät Shift mechanism, gear Appareil commande  Actros
19450	 4 057822 194505		
		000 260 6198 000 260 7998	Schaltgerät Shift mechanism, with sensor Appareil commande  Actros

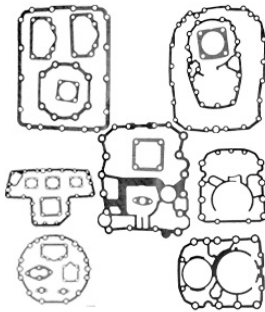
KTK No.	RF No.	Bezeichnung Description Désignation	Erläuterungen Remarks Remarques
19633	 4 057822 196332	 002 260 0663 001 260 1863 Schaltzylinder Shifting cylinder Cylindre de commande	
19453	 4 057822 194536	 001 260 3463 Schaltzylinder Shifting cylinder Cylindre de commande	Actros
10918	 4 057822 109182	 000 260 4663 Schaltzylinder Shifting cylinder Vérin de commande	L series SK/MK/NG
10919	 4 057822 109195	 000 260 4763 000 260 5363 000 260 3563 Schaltzylinder Shifting cylinder Vérin de commande	L series SK/MK/NG



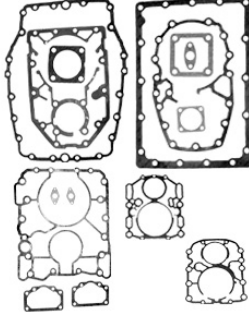

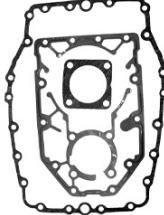









KTK No.		RF No.	Bezeichnung Description Désignation	Erläuterungen Remarks Remarques
08000	 4 057822 080006			
		000 268 1280	Dichtung Gasket / Joint	NG/SK AK 690
07396	 4 057822 073961			
		000 262 1880	Dichtung Gasket / Joint	
06501	 4 057822 065010			
			Dichsatz Gasket kit / Kit de joints	AK 690
08980	 4 057822 089801			
			Dichsatz Seal kit Jeu de joints	AK 690 1268 298 903
06939	 4 057822 069390			
		343 261 0752	Dichtung Shim Joint	AK 690 5S 111 GP 149x129x.03 L/SK/MK/NG





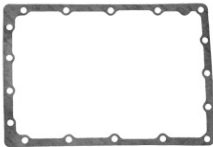





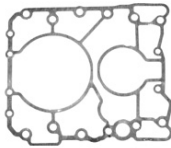

KTK No.	RF No.	Bezeichnung Description Désignation	Erläuterungen Remarks Remarques
<p><b>07688</b></p>   <p>4 057822 076889</p> 	<p>000 586 0526 000 586 5226</p>	<p>Dichtsatz Gasket kit / Kit de joints</p>	<p>719 5 S 90 GP</p>
<p><b>09547</b></p>   <p>4 057822 095475</p> 		<p>Dichtsatz Gasket kit / Kit de joints</p>	<p>AK690</p>
<p><b>07721</b></p>   <p>4 057822 077211</p> 	<p>000 268 6180</p>	<p>Dichtung Gasket / Joint</p>	
<p><b>07727</b></p>   <p>4 057822 077273</p> 	<p>001 264 0380</p>	<p>Dichtung Gasket / Joint</p>	
<p><b>07722</b></p>   <p>4 057822 077225</p> 	<p>000 268 5880</p>	<p>Dichtung Gasket / Joint</p>	



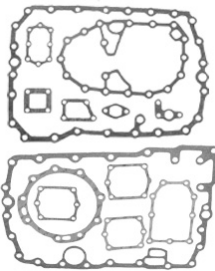

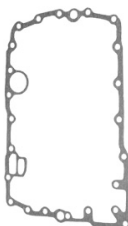









KTK No.	RF No.	Bezeichnung Description Désignation	Erläuterungen Remarks Remarques
07723	 4 057822 077230		
  	000 268 5180	Dichtung Gasket / Joint	
07724	 4 057822 077245		
  	000 268 6380	Dichtung Gasket / Joint	
07725	 4 057822 077256		
  	000 268 6280	Dichtung Gasket / Joint	
06930	 4 057822 069302		
  	000 262 2380	Dichtung Gasket / Joint	5 S 90 GP 5 S 110 GP 5 S 111 GP
06477	 4 057822 064775		
  	000 264 7680	Dichtung Gasket / Joint	

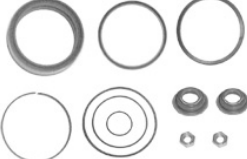













KTK No.	RF No.	Bezeichnung Description Désignation	Erläuterungen Remarks Remarques
07720			
	 4 057822 077204  000 262 2580	Dichtung Gasket / Joint	
	 4 057822 077321	Dichtsatz Gasket kit / Kit de joints	5 S 90 GPA
	 4 057822 089821	Dichtsatz Seal kit Kit de joints	5 S 90 GPA
	 4 057822 076872  000 260 2868	Dichtsatz Gasket kit / Kit de joints	SK/MK/NG 5 S 110 GP 5 S 111 GP
	 4 057822 064685	Dichtsatz Gasket kit / Kit de joints	

















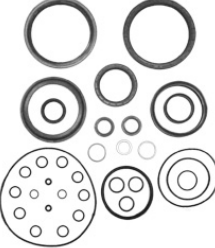













KTK No.	RF No.	Bezeichnung Description Désignation	Erläuterungen Remarks Remarques
06475			
 	 000 268 6080	Dichtung Gasket / Joint	
06476			
 	 000 264 9980	Dichtung Gasket / Joint	
06477			
 	 000 264 7680	Dichtung Gasket / Joint	
07726			
 	 000 268 5780	Dichtung Gasket / Joint	
06930			
 	 000 262 2380	Gasket	





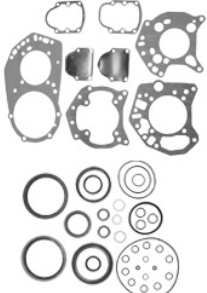



KTK No.	RF No.	Bezeichnung Description Désignation	Erläuterungen Remarks Remarques
07728	 4 057822 077284		
		000 268 5980	Dichtung Gasket / Joint
08981	 4 057822 089816		
			Dichtsatz 5 S 110 GP Seal kit 5 S 111 GP Kit de joints
06486	 4 057822 064869		
		000 260 1668 000 260 3768	Dichtsatz 16 S 130 Gasket kit / Kit de joints 16 S 160
09600	 4 057822 096003		
		000 261 5680	Dichtung Gasket / Joint
06487	 4 057822 064879		
		000 262 2480	Dichtung 16 S 130 Gasket / Joint 16 S 160















KTK No.	RF No.	Bezeichnung Description Désignation	Erläuterungen Remarks Remarques
<p><b>08979</b></p>   <p>4 057822 089872</p> 		<p>Dichtsatz Seal kit Kit de joints</p>	<p>16 S 130 16 S 160</p>
<p><b>08984</b></p>   <p>4 057822 089842</p> 	<p>000 267 0697</p>	<p>Wellendichtring Seal Bague d'etanchéité</p>	<p>16 S 130 16 S 160 25x35x10/4.5</p>
<p><b>08985</b></p>   <p>4 057822 089854</p> 		<p>Dichtsatz Seal kit Kit de joints</p>	<p>16 S 130 16 S 160</p>
<p><b>06944</b></p>   <p>4 057822 069445</p> 		<p>Dichtsatz Gasket kit / Kit de joints</p>	<p>G125, 135, 155, 180</p>
<p><b>06738</b></p>   <p>4 057822 067389</p> 	<p>389 261 1180</p>	<p>Dichtung Gasket / Joint</p>	

KTK No.	RF No.	Bezeichnung Description Désignation	Erläuterungen Remarks Remarques
06739	 4 057822 067390		
		389 261 1280	Dichtung Gasket / Joint
06740	 4 057822 067406		
		389 268 2080	Dichtung Gasket / Joint
06741	 4 057822 067412		
		389 268 2180	Dichtung Gasket / Joint
06743	 4 057822 067436		
		389 268 1480	Dichtung Gasket / Joint
06742	 4 057822 067426		
		389 268 1180	Dichtung Gasket / Joint















KTK No.		RF No.	Bezeichnung Description Désignation	Erläuterungen Remarks Remarques
06744	 4 057822 067443			
		387 261 4280	Dichtung Gasket / Joint	
06888	 4 057822 068884			
		389 261 1480	Dichtung Gasket / Joint	
08983	 4 057822 089826			
			Dichsatz Seal kit /Kit de joints	
10989	 4 057822 109893			
		013 997 7347	Wellendichtring Oil seal for GB / Bague d'etanchéité	
10990	 4 057822 109903			
		013 997 7247	Wellendichtring Oil seal / Bague d'etanchéité	

KTK No.	RF No.	Bezeichnung Description Désignation	Erläuterungen Remarks Remarques
10991	 4 057822 109915		
		000 267 0197 Wellendichtring Oil seal for GB / Bague d'etanchéité	
19669	 4 057822 196692		
		006 997 6447 Seal ring - Small	
19670	 4 057822 196702		
		014 997 3647 Seal ring - Big	
11625	 4 057822 116253		
		Kit with Seal	
15517	 4 057822 155174		
		019 997 0547 019 997 0647 Wellendichtring Oil seal Bague d'etanchéité	56x72x8 ACTROS ATEGO / AXOR 541/542 714/715 900/902/904/906















KTK No.	RF No.	Bezeichnung Description Désignation	Erläuterungen Remarks Remarques	
07650	 4 057822 076502			
		387 262 1093	Ring Lock ring Torique	G 155, 180 ACTROS/AXOR SK/MK/NG
07649	 4 057822 076498			
		387 262 0893	Drahring Lock ring Torique	G 155, 180 ACTROS/AXOR SK/MK/NG
07689	 4 057822 076894			
		389 262 0293	Drahring Lock ring Torique	G 155, 180 ACTROS/AXOR SK/MK/NG















KTK No.	RF No.	Bezeichnung Description Désignation	Erläuterungen Remarks Remarques	
08880	 4 057822 088804			
		000 268 6289 000 268 4689	Kugelgelenk Ball joint Rotule	M12 - R/H L = 55 L/SK/MK/NG
08881	 4 057822 088811			
		000 268 6189 000 268 4789	Kugelgelenk Ball joint Rotule	M12 - L/H L series L/SK/MK/NG
08882	 4 057822 088828			
		000 268 4889	Kugelgelenk Ball joint Rotule	R/H - L = 86 M14x1.5 SK/MK/NG
13367	 4 057822 133675			
		000 996 6745 375 268 0089	Kugelgelenk Ball joint Rotule	ACTROS/AXOR L/H M12x1.5 L = 60
13368	 4 057822 133689			
		000 996 6645 375 268 0189	Kugelgelenk Ball joint Rotule	ACTROS/AXOR R/H M12x1.5 L = 60

















KTK No.		RF No.	Bezeichnung Description Désignation	Erläuterungen Remarks Remarques
13372	 4 057822 133726			
		000 996 6845 000 996 7045 375 996 0045	Kugelgelenk Ball joint R/H Rotule	M14x1.5 ACTROS/ATEGO SK/MK/NG/LK L = 55
13774	 4 057822 137745			
		000 268 5989	Kugelgelenk Ball joint R/H Rotule	M14x1.5 ACTROS/ATEGO SK/MK/NG/LK tL = 55
13373	 4 057822 133736			
		000 996 5645 000 996 51 45	Kugelgelenk Ball joint L/H	M12x1.5 ACTROS/AXOR Rotule SK/MK/NG L = 56
13374	 4 057822 133745			
		000 996 5545	Gelenkstück Gearbox end R/H Articulation	M12x1.5 ACTROS/AXOR SK/MK/NG
13369	 4 057822 133694			
		375 260 0537	Kugelgelenk Ball joint Rotule	AXOR 375 L = 91



KTK No.	RF No.	Bezeichnung Description Désignation	Erläuterungen Remarks Remarques
13715			
	000 268 7045	Kugelgelenk Ball joint R/H Rotule	M14x1.5 L = 82 402/422 New version Turbo type 8 Cyl;
13775			
	000 996 4845	Kugelgelenk Ball joint RH Rotule	M26x1.5 L = 75 ACTROS





KTK No.	RF No.	Bezeichnung Description Désignation	Erläuterungen Remarks Remarques
12074			
	 4 057822 120740  	004 981 5801  Rollenlager Bearing, Main shaft front Palier à rouleaux	30mm 343/346 350/363 717/718/719
12079			
	 4 057822 120795  	002 981 7201  Rollenlager Bearing, Drive shaft front Palier à rouleaux	84x157x28 363 717/718/719
12080			
	 4 057822 120801  	Rollenlager / Bearing Palier à rouleaux Gearbox	50x100x38 522380
12081			
	 4 057822 120818  	008 981 2805  Rollenlager Bearing, main shaft front Palier à rouleaux	40x91x33 714/715
12082			
	 4 057822 120825  	012 981 9305  Rollenlager Bearing, main shaft rear Palier à rouleaux	ACTROS/AXOR SK/MK/NG 714/715 59x137x33/35

KTK No.	RF No.	Bezeichnung Description Désignation	Erläuterungen Remarks Remarques
12083	 4 057822 120832		
		011 981 1305 Rollenlager Bearing, drive shaft front Palier à rouleaux	ACTROS/AXOR SK/MK/NG 714/715 74x139x32/35
12084	 4 057822 120849		
		012 981 9205 Rollenlager Bearing, counter shaft rear Palier à rouleaux	ACTROS/AXOR SK/MK/NG 714/715 60x130x33/35
12087	 4 057822 120870		
		004 981 7801 Rollenlager Bearing, 4th speed gear Palier à rouleaux	L series - 62mm SK/MK/NG 710/717/718
12086	 4 057822 120863		
		005 981 8701 Rollenlager Bearing, main shaft rear Palier à rouleaux	717/718/719 70x150x35
12088	 4 057822 120887		
		Rollenlager Gearbox Bearing Palier à rouleaux	55x120x29 NUP311











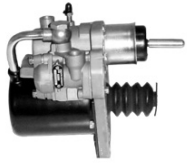



KTK No.	RF No.	Bezeichnung Description Désignation	Erläuterungen Remarks Remarques
12089	 4 057822 120894	  Rollenlager Gearbox Bearing Palier à rouleaux	  50x110x27 NU310EN
12085	 4 057822 120856	  Rollenlager Gearbox Bearing Palier à rouleaux	  70x150x35 6314
07646	 4 057822 076465	  Rollenlage Bearing, Gearbox Palier à rouleaux	  80x140x26 529084















KTK No.	RF No.	Bezeichnung Description Désignation	Erläuterungen Remarks Remarques	
14776	 4 057822 147761			
		000 267 2119 000 267 0419 000 267 0819	Zylindergehäuse Cylinder housing Carter de cylindre	16S 130/160 SK/MK/NG 710/717/718
14778	 4 057822 147785			
		000 267 0519	Zylindergehäuse Cylinder housing Carter de cylindre	16S 130/160 SK/MK/NG 710/717/718
14777	 4 057822 147778			
		945 267 1119	Zylindergehäuse Cylinder housing Carter de cylindre	G 155/210 714/715 SK/MK/NG



KTK No.	RF No.	Bezeichnung Description Désignation	Erläuterungen Remarks Remarques
08419			
	201 291 0282	Pedalgummi Clutch pedal rubber Caoutchouc de pédale	2635/2631 LP ACTROS / ATEGO AXOR/ SK/MK/NG
07531			
	201 292 0082	Pedalgummi Brake pedal rubber Caoutchouc de pédale	1735, 1935, 2429, 2435LS ACTROS/ ATEGO AXOR/SK/MK/NG









KTK No.		RF No.	Bezeichnung Description Désignation	Erläuterungen Remarks Remarques
19715	 4 057822 197155	001 295 9106	Kupplungszyylinder Clutch cylinder Cylindre d'embrayage	Atego/Axor 115mm
22161	 4 057822 221614	002 295 0706	Kupplungszyylinder Clutch cylinder Cylindre d'embrayage	ACTROS
22162	 4 057822 221621	001 295 7406	Kupplungszyylinder Clutch cylinder Cylindre d'embrayage	422/423
22160	 4 057822 221607	002 295 0406 001 295 9306 001 295 9506	Kupplungszyylinder Clutch cylinder Cylindre d'embrayage	Actros MP1



















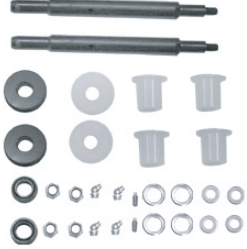



KTK No.	RF No.	Bezeichnung Description Désignation	Erläuterungen Remarks Remarques
<p><b>08518</b></p>  <p>4 057822 085186</p>  	<p>001 295 3107 001 295 6707</p>	<p>Kupplungsservo Clutch Servo Servo d'embrayage</p>	<p>☞ 95 SK/MK/NG</p>
<p><b>08525</b></p>  <p>4 057822 085254</p>  	<p>000 290 3267</p>	<p>Reparaturatz Repair kit Kit de réparation</p>	<p>For 001 295 3107</p>
<p><b>10073</b></p>  <p>4 057822 100735</p>  	<p>000 295 0918 000 295 0218 000 295 1418</p>	<p>Kupplungsservo Clutch Servo Servo d'embrayage</p>	<p>SK/MK/NG</p>
<p><b>08950</b></p>  <p>4 057822 089504</p>  	<p>000 290 0347</p>	<p>Reparaturatz Repair kit Kit de réparation</p>	<p>For 000 295 0918</p>
<p><b>19505</b></p>  <p>4 057822 195052</p>  	<p>000 295 0318 000 295 0618 000 295 1518</p>	<p>Kupplungsservo Clutch Servo Servo d'embrayage</p>	<p>3234/3235</p>









KTK No.	RF No.	Bezeichnung Description Désignation	Erläuterungen Remarks Remarques
<p data-bbox="280 197 360 226">09605</p>  <p data-bbox="523 264 691 286">4 057822 096052</p>  	<p data-bbox="751 349 919 416">000 290 0667 000 290 3267</p>	<p data-bbox="994 349 1182 461">Reparatursatz Repair kit Kit de réparation</p>	<p data-bbox="1297 349 1509 416">For 001 295 3107 SK/MK/NG series</p>
<p data-bbox="280 577 360 607">08952</p>  <p data-bbox="523 645 691 667">4 057822 089528</p>  		<p data-bbox="994 730 1182 842">Reparatursatz Repair kit Kit de réparation</p>	<p data-bbox="1297 775 1509 842">For 000 295 0318 SK/MK/NG</p>
<p data-bbox="280 969 360 999">11118</p>  <p data-bbox="523 1037 691 1059">4 057822 111182</p>  	<p data-bbox="751 1126 919 1238">000 254 0047 000 295 2818 000 254 0247</p>	<p data-bbox="994 1126 1206 1238">Kupplungsservo Clutch servo Servo d'embrayage</p>	<p data-bbox="1297 1126 1477 1155">ACTROS/AXOR</p>
<p data-bbox="280 1361 360 1391">11119</p>  <p data-bbox="523 1429 691 1451">4 057822 111199</p>  	<p data-bbox="751 1518 919 1547">000 290 1747</p>	<p data-bbox="994 1518 1182 1630">Reparatursatz Repair kit Kit de réparation</p>	
<p data-bbox="280 1753 360 1783">16111</p>  <p data-bbox="523 1821 691 1843">4 057822 161118</p>  	<p data-bbox="751 1910 919 1939">000 295 0818</p>	<p data-bbox="994 1910 1206 2022">Kupplungsservo Clutch servo Servo d'embrayage</p>	<p data-bbox="1297 1910 1509 1977">OM 356/401/445 SK/MK/NG</p>







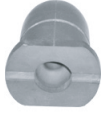

KTK No.	RF No.	Bezeichnung Description Désignation	Erläuterungen Remarks Remarques
16112			
	000 254 0147	Kupplungsservo Clutch servo Servo d'embrayage	384/693 712/715/958 SK/MK/NG
16115			
	000 295 0018	Kupplungsservo Clutch servo Servo d'embrayage	SK/MK 371/652/655 656/659
19506			
	000 295 0718 000 295 1318	Kupplungsservo Clutch Servo Servo d'embrayage	

KTK No.	RF No.	Bezeichnung Description Désignation	Erläuterungen Remarks Remarques	
08463	 4 057822 084639			
		381 300 1430 381 300 0330	Drahtzug Accelerator cable Câble	L = 1530mm 380/381/383/385 387/389/391/395 617/620/621 623/624 SK/MK/NG
08461	 4 057822 084615			
		381 300 1730 381 300 0530	Drahtzug Accelerator cable Câble	L = 1330mm 387/389/391 393/395/620 621/622/623 624 SK/MK/NG
08462	 4 057822 084622			
		620 300 0130 620 300 0230 620 300 0330	Drahtzug Accelerator cable Câble	L = 2150mm SK/MK/NG















KTK No.	RF No.	Bezeichnung Description Désignation	Erläuterungen Remarks Remarques
11774			
	 4 057822 117740  	624 300 0304    Reparatursatz 381 301 0032    Repair kit, pedal 615 300 0004    Kit de réparation	SK/MK/NG series LK
22023			
	 4 057822 220235  	941 300 0104    Fahrpedal Accelerator pedal Pédale d'accélérateur	Actros





KTK No.	RF No.	Bezeichnung Description Désignation	Erläuterungen Remarks Remarques
<p><b>07690</b></p>  <p>4 057822 076900</p>  	<p>387 310 0077 387 586 0131</p>	<p>Reparaturatz Repair kit Kit de réparation</p>	<p>380, 385, 381, 383, 387, 389. 393, 624, 656 SK/MK/NG Front</p>
<p><b>07691</b></p>  <p>4 057822 076917</p>  	<p>387 586 0531 387 891 0957 620 310 0077</p>	<p>Reparaturatz Repair kit Kit de réparation</p>	<p>380, 381, 383, 385, 387, 393, 395 SK/MK/NG Front</p>
<p><b>07692</b></p>  <p>4 057822 076924</p>  	<p>381 586 0031</p>	<p>Reparaturatz Repair kit Kit de réparation</p>	<p>1626, 1632, 1922, 1926, 1932, 2626, 2632, 3228 1935 SK/MK/NG Front</p>
<p><b>21242</b></p>  <p>4 057822 212421</p>  	<p>942 317 1812 930 317 0012</p>	<p>Buchse Bushing Bague</p>	<p>Actros</p>
<p><b>22922</b></p>  <p>4 057822 229221</p>  	<p>942 317 2012</p>	<p>Buchse Bushing Bague</p>	<p>Actros</p>







KTK No.	RF No.	Bezeichnung Description Désignation	Erläuterungen Remarks Remarques
07522	 4 057822 075224		
		363 891 0717	Buchse / Bushing Bague
07528	 4 057822 075286		
		363 891 0223	Zusatzfeder Rubber Buffer ressort auxiliaire
15495	 4 057822 154950		
		318 586 0031	Reparatursatz Repair kit Kit de réparation
		L series 314/316/318 322/338/347/349 352/355/684	

KTK No.	RF No.	Bezeichnung Description Désignation	Erläuterungen Remarks Remarques
09082			
 <p>4 057822 090821</p>			
	383 324 0008	Zusatzfeder Buffer ressort auxiliaire	SK/MK/NG series
			
15508			
 <p>4 057822 155087</p>			
	000 322 3285 000 322 1285 000 322 22 85	Buchse Bushing Bague	ACTROS/AXOR ATEGO SK/MK/NG
			
07718			
 <p>4 057822 077181</p>			
	389 320 0065 389 586 0132	Reparatursatz Repair kit Kit de réparatio	1926, 1932, 1935, 1944, 2435 ∅30x148 L series SK/MK/NG
			

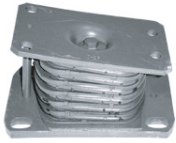

KTK No.	RF No.	Bezeichnung Description Désignation	Erläuterungen Remarks Remarques
07717	 4 057822 077174		
		395 320 0265 395 586 0232 Reparatursatz Repair kit Kit de réparatio	1626, 1632 1638, 1928 2028K, 3228S ∅25x140 L series SK/MK/NG
14304	 4 057822 143046		
		941 326 0050 Büchse Bush Bague	ACTROS/AXOR ATEGO ∅82x110x66.5
21240	 4 057822 212407		
		000 325 0285 000 325 0785 000 325 0885 Buchse Bush, leaf spring Bague	24x62x106
21241	 4 057822 212414		
		000 322 0985 000 322 0885 Buchse Bush, leaf spring Bague	24x60.5x50
21231	 4 057822 212315		
		000 323 8185 Buchse Bush, stabiliser Bague	Actros/Atego

KTK No.	RF No.	Bezeichnung Description Désignation	Erläuterungen Remarks Remarques
19191	 4 057822 191917	000 323 7985 000 323 7485 000 323 7585 000 323 7685	Buchse, Stabilisator      Actros/Atego Bushing, stabilizer      Axor/Zetro Douille, barre stabilisatrice
19188	 4 057822 191887	000 326 4481 000 326 4781	Buchse, Stabilisator      Actros/Atego Bushing, stabilizer      Axor Douille, barre stabilisatrice 57.5mm Rear Axle
21233	 4 057822 212339	000 326 2481 000 323 5985 000 326 2981	Buchse, Stabilisator      40x50.5x55 Bushing, stabilizer      Atego/Actros Douille, barre stabilisatrice
21234	 4 057822 212346	000 326 2681 000 326 3081 000 326 3281	Buchse, Stabilisator      48x74x57 Bushing, stabilizer Douille, barre stabilisatrice

KTK No.	RF No.	Bezeichnung Description Désignation	Erläuterungen Remarks Remarques
11197			
	 4 057822 111977 	000 325 0496    Hohlfeder 000 325 0896    Hollow spring 000 325 0696    Ressort évidé	ACTROS H: 132
10940			
	 4 057822 109400 	000 325 0596    Hohlfeder 000 325 0796    Hollow spring Ressort évidé	ACTROS/AXOR H: 152

**KTK No.**

20686





**RF No.**





000 328 4530

**Bezeichnung  
Description  
Désignation**Ventil  
Levelling Valve  
Soupape**Erläuterungen  
Remarks  
Remarques**

Actros/Atego



KTK No.	RF No.	Bezeichnung Description Désignation	Erläuterungen Remarks Remarques
08884	 4 057822 088842	001 330 0135 Kugelgelenk Tie rod end R/H Rotule	M20x1.5 M30x1.5 L = 120mm NG/LK/MK/SK
08883	 4 057822 088835	302 330 0235 000 330 0148 Kugelgelenk Tie rod end L/H Rotule	M20x1.5 M30x1.5 L = 120mm
21100	 4 057822 211004	942 330 0403 942 330 0303 942 330 1603 942 330 2403 Spurstange Tie rod Barre d'accouplement de roue	1664mm Actros/Axor
21101	 4 057822 211011	942 330 1103 942 330 0003 942 330 0103 942 330 0203 942 330 0703 Spurstange Tie rod Barre d'accouplement de roue	1735mm Actros/Axor
12815	 4 057822 128159	000 331 0385 335 460 0096 Manschette Boot / Manchon	L series SK/MK/NG

KTK No.	RF No.	Bezeichnung Description Désignation	Erläuterungen Remarks Remarques
21566	 4 057822 215668	  949 330 1603 949 330 0703 949 330 0603 949 330 1503	Spurstange 1620mm Tie rod Actros 2648K Barre d'accouplement de roue
23504	 4 057822 235048	  949 330 0503 949 330 0403	Spurstange 1690 mm Tie rod Barre d'accouplement de roue

<b>KTK No.</b>	<b>RF No.</b>	<b>Bezeichnung Description Désignation</b>	<b>Erläuterungen Remarks Remarques</b>
----------------	---------------	--	--















23008

















942 334 0015















ABS ring



















KTK No.	RF No.	Bezeichnung Description Désignation	Erläuterungen Remarks Remarques
<p>07719</p>  <p>4 057822 077198</p>  	<p>391 330 0019 389 586 0033</p>	<p>Reparaturatz Repair kit Kit de réparation</p>	<p>1628, 1633, 2626L/LB, 2628, 2623, 2636, 3028 L seires ∅50/∅51x223 SK/MK/NG</p>
<p>13795</p>  <p>4 057822 137953</p>  	<p>942 332 0006</p>	<p>Bolzen Pin Boulon</p>	<p>ACTROS/AXOR ATEGO ∅50mm</p>
<p>13782</p>  <p>4 057822 137823</p>  	<p>655 330 0019</p>	<p>Reparaturatz Repair kit Kit de réparation</p>	<p>SK/MK/NG Track rod lever side 733 VO 4/13 DL-7 739 VD 4/26 DL-7.5</p>
<p>13796</p>  <p>4 057822 137960</p>  	<p>655 330 0019A</p>	<p>Reparaturatz Repair kit Kit de réparation</p>	<p>ACTROS SK/MK/NG</p>
<p>13783</p>  <p>4 057822 137830</p>  	<p>001 981 7818 004 981 05 05</p>	<p>Rollenlager Bearing Palier à rouleaux</p>	<p>SK/MK/NG ACTROS 50.25x78x22</p>



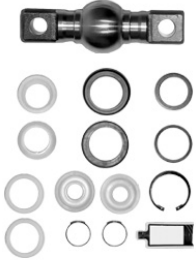

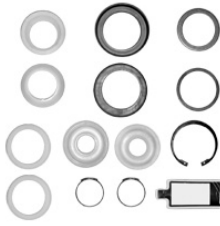



























KTK No.	RF No.	Bezeichnung Description Désignation	Erläuterungen Remarks Remarques
13785			
	 4 057822 137854  	009 981 3810 Rollenlager 009 981 4110 Needle bearing 016 981 2510 Palier à rouleaux	ACTROS/AXOR ATEGO SK/MK/NG 25x58x50
13786			
	 4 057822 137861  	Wellendichtring Sealring Bague d'etanchéité	51x58x4 ACTROS/AXOR
13787			
	 4 057822 137878  	Scheibe Washer / Rondelle	OX56.5X1.5 ACTROS/AXOR
13788			
	 4 057822 137885  	655 330 0419 Reparatursatz Repair kit Kit de réparation Steering arm side	ACTROS/AXOR ATEGO 50x78x25
13797			
	 4 057822 137977  	655 330 0419A Reparatursatz Repair kit Kit de réparation	ACTROS/AXOR ATEGO















KTK No.	RF No.	Bezeichnung Description Désignation	Erläuterungen Remarks Remarques
13789	 4 057822 137892		
		Rollenlager	BAFSB353323A/HA3 King pin bearing Palier à rouleaux
13790	 4 057822 137908		
		020 997 4947 Wellendichtring Sealring Bague d'etanchéité	70X79X5 ACTROS/AXOR ATEGO
13791	 4 057822 137915		
		942 332 0162 Scheibe Washer / Rondelle	51x70x6 ACTROS/AXOR ATEGO
13792	 4 057822 137922		
		655 330 0619 Reparatursatz Repair kit Kit de réparation	Steering arm side ACTROS/AXOR SK/MK/NG Bearing : 13789
13798	 4 057822 137984		
		655 330 0619A Reparatursatz Repair kit Kit de réparation	ACTROS/AXOR SK/MK/NG







KTK No.	RF No.	Bezeichnung Description Désignation	Erläuterungen Remarks Remarques
17100	 4 057822 171001	655 330 0719	 Reparatursatz Repair kit Kit de réparation  Steering track side ACTROS/AXOR ATEGO 223x50 Bearing : 13785
17101	 4 057822 171018	655 330 0719A	 Reparatursatz Repair kit Kit de réparation  Steering track side ACTROS/AXOR ATEGO
13793	 4 057822 137939	942 980 0110	 Rollenlager King pin bearing Palier à rouleaux  51x80x22 ACTROS/AXOR ATEGO
13799	 4 057822 137991	655 330 0519A	 Reparatursatz Repair kit Kit de réparation  ACTROS/AXOR
13794	 4 057822 137946	655 330 0519	 Reparatursatz Repair kit Kit de réparation  ACTROS/AXOR 50x80x25

KTK No.	RF No.	Bezeichnung Description Désignation	Erläuterungen Remarks Remarques
<p><b>08466</b></p>  <p>4 057822 084660</p>  	<p>000 350 0213 000 586 1433</p>	<p>Reparatursatz Repair kit Kit de réparation</p>	<p>SK/MK/NG 80x21/152</p>
<p><b>08467</b></p>  <p>4 057822 084677</p>  	<p>000 586 1533</p>	<p>Reparatursatz Repair kit Kit de réparation</p>	
<p><b>09083</b></p>  <p>4 057822 090838</p>  	<p>343 586 0032</p>	<p>Reparatursatz Repair kit Kit de réparation</p>	<p>L series 80xM39x1.5/162.5</p>





KTK No.	RF No.	Bezeichnung Description Désignation	Erläuterungen Remarks Remarques
08464			
  	4 057822 084646	000 350 0413 000 586 1235	Reparatursatz Repair kit Kit de réparation 95mm $\varnothing$ L series SK/MK/NG
08465			
  	4 057822 084653	000 350 0613 000 586 1135	Reparatursatz Repair kit Kit de réparation 84.9mm $\varnothing$ L series SK/MK/NG
12071			
  	4 057822 120719	000 350 0113	Reparatursatz Repair kit Kit de réparation 108mm $\varnothing$ L series
15486			
  	4 057822 154868	000 350 0213 F	Reparatursatz Repair kit Kit de réparation 80mm $\varnothing$ L series SK/MK/NG
18735			
  	4 057822 187354	000 350 2205	Reparatursatz Repair kit Kit de réparation 75x25x130 Actros/Axor















KTK No.	RF No.	Bezeichnung Description Désignation	Erläuterungen Remarks Remarques
18736	 4 057822 187361		
		000 350 2305 Reparatursatz Repair kit Kit de réparation	85x25x152 Actros/Axor
18737	 4 057822 187378		
		000 350 2405 Reparatursatz Repair kit Kit de réparation	100x25x152 Actros/Axor
15485	 4 057822 154851		
		941 323 0050 Reparatursatz Repair kit Kit de réparation	73.5x19/100 ACTROS AXOR
19980	 4 057822 199807		
		000 330 0207 Reparatursatz Repair kit Kit de réparation	75mm 405
20490	 4 057822 204907		
		000 330 1411 Reparatursatz Repair kit Kit de réparation	99x67x17















KTK No.		RF No.	Bezeichnung Description Désignation	Erläuterungen Remarks Remarques
21232	 4 057822 212322			
		000 350 2105 000 350 4605	Reparatursatz Repair kit Kit de réparation	75x151x25
21235	 4 057822 212353			
		000 350 3605	Reparatursatz Repair kit Kit de réparation	108x152x25
21236	 4 057822 212360			
		000 350 3705	Reparatursatz Repair kit Kit de réparation	85x130x23
21237	 4 057822 212377			
		000 350 0511	Reparatursatz Repair kit Kit de réparation	67x130x19
21238	 4 057822 212384			
		000 350 2005 000 350 4705	Reparatursatz Repair kit Kit de réparation	67x130x23



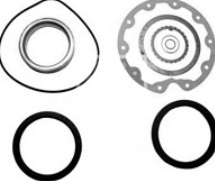

KTK No.	RF No.	Bezeichnung Description Désignation	Erläuterungen Remarks Remarques
21239			
	 4 057822 212391  	000 350 1313  Reparatursatz Repair kit Kit de réparation	75x152x21
23131			
	 4 057822 231316  	000 350 3305  Reparatursatz Repair kit Kit de réparation	

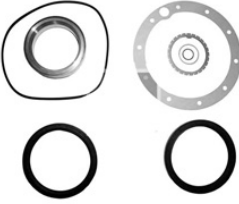













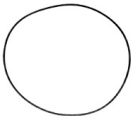

KTK No.	RF No.	Bezeichnung Description Désignation	Erläuterungen Remarks Remarques
07701	 4 057822 077013	385 351 0172 385 351 0072	Flachbundmutter 335, 343, 352, Flat collar nut (New version) 353, 360, 363, Ecrou double-hexagonal 380, 383, 385 M40 x 1.5 SW 50 387, 389 For Flange 130mm
07702	 4 057822 077020	385 351 0672	Flachbundmutter 335, 346, 353, Flat collar nut 381, 383, 385, Ecrou double-hexagonal 387, 389, 393, M45 x 1.5, SW 55 395, 620, 621, For Flange 165mm 623, 624
07703	 4 057822 077037	346 353 0072	Flachbundmutter 343, 346, 395 Flat collar nut 624 Ecrou double-hexagonal M55 x 1.5, SW 65 For Flange 180mm
07704	 4 057822 077044	385 351 0572	Flachbundmutter 343, 346, 395 Flat collar nut, new version 624 Ecrou double-hexagonal 12 - Edged For Flange 180mm
07931	 4 057822 079314	000 912 012 047 000 912 012 219	Schraube SK/MK/NG Screw - L key 381, 383, 385 Vis















KTK No.		RF No.	Bezeichnung Description Désignation	Erläuterungen Remarks Remarques
17175	 4 057822 171759			
		940 350 0335	Reparaturset Repair kit Kit de réparation	ACTROS/AXOR Rear 748
17176	 4 057822 171766			
		346 356 0073	Sicherungsblech Lock ring Tole d'arrêtoir	89x106x2 ACTROS/AXOR
17177	 4 057822 171773			
		650 356 0080G	Dichtung Gasket / Joint	217x276x1 ACTROS/AXOR
17178	 4 057822 171780			
		346 356 0027	Scheibe Racer washer Rondelle	ACTROS/AXOR 147x175x2
07705	 4 057822 077051			
		346 356 0315 346 356 1415	Druckring Thrust ring Frêt de joint speed	145 x 115 x 32 L series SK/MK/NG ACTROS/ATEGO















KTK No.		RF No.	Bezeichnung Description Désignation	Erläuterungen Remarks Remarques
17181	 4 057822 171810			
		940 350 0035	Reparatursatz Repair kit Kit de réparation	ACTROS/ATEGO 748
19985	 4 057822 199852			
		940 350 0235	Reparatursatz Repair kit Kit de réparation	ACTROS
19781	 4 057822 197810			
		346 334 0080 650 356 0180	Dichtung, Nabendeckel Gasket, hub cover Joint, chapeau de moyeu	Actros/Axor
19986	 4 057822 199869			
		940 350 0435	Reparatursatz Seal kit, rear wheel Kit de réparation	Actros/Axor/Atego
19987	 4 057822 199876			
		940 350 0535	Reparatursatz Seal kit, rear wheel Kit de réparation	Actros/Axor/Atego

KTK No.	RF No.	Bezeichnung Description Désignation	Erläuterungen Remarks Remarques
19988	 4 057822 199883	940 350 0635 Reparatursatz Seal kit, rear wheel Kit de réparation	Actros/Axor/Atego
19989	 4 057822 199890	940 350 0835 Reparatursatz Seal kit, rear wheel Kit de réparation	Actros/Axor/Atego
19990	 4 057822 199906	942 356 0715 942 356 0015 942 356 0315 Sesor ring, ABS	Actros/Axor/Atego
07715	 4 057822 077150	355 356 0915 355 356 1215 Druckring Thrust ring Frêt de joint speed	145 x 110 x 32 SK/MK/NG ACTROS/AXOR
07716	 4 057822 077167	355 356 0126 Nutmutter Grooved nut Ecrou à gorge	L series SK/MK/NG ACTROS/AXOR



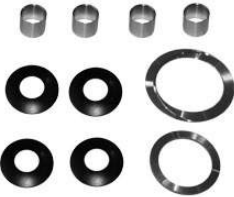

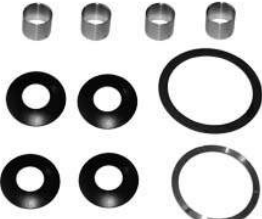

KTK No.	RF No.	Bezeichnung Description Désignation	Erläuterungen Remarks Remarques
<p>10115</p>  <p>4 057822 101152</p>  	<p>346 334 0080</p>	<p>Reparaturset Seal kit Kit de réparation</p>	<p>145X175X14/12 145X175X13 09899 - O ring ACTROS/AXOR 349/740/748/749 L series SK/MK/NG</p>
<p>09899</p>  <p>4 057822 098995</p>  	<p>001 997 6848 016 997 4048</p>	<p>O-Ring O-ring / Joint torique</p>	
<p>09616</p>  <p>4 057822 096168</p>  	<p>016 997 5647 013 997 0547</p>	<p>Wellendichtring Seal Bague d'etanchéité</p>	<p>145x175x14/12</p>
<p>09617</p>  <p>4 057822 096175</p>  	<p>013 997 9447</p>	<p>Wellendichtring Seal Bague d'etanchéité</p>	<p>145x175x13</p>
<p>14305</p>  <p>4 057822 143053</p>  	<p>013 997 7346</p>	<p>Wellendichtring Seal Bague d'etanchéité</p>	<p>120x150x15/20.2 ACTROS/SK/MK/NG 739/749</p>











KTK No.		RF No.	Bezeichnung Description Désignation	Erläuterungen Remarks Remarques
12585	 4 057822 125851			
		015 997 4947	Wellendichtring Oil seal Bague d'etanchéité	145x175/205x9/14 ACTROS/AXOR ATEGO
12587	 4 057822 125875			
		020 997 0547	Wellendichtring Oil seal Bague d'etanchéité	145x175/205x18/20 ACTROS/AXOR ATEGO
12589	 4 057822 125899			
			Wellendichtring Oil seal Bague d'etanchéité	135X175/205X18 ACTROS Rear wheel
15539	 4 057822 155391			
		946 356 0015	Druckring Thrust ring Frêt de joint speed	145 x 119 x 26 741/746/748 ACTROS/AXOR ATEGO
10180	 4 057822 101800			
		346 353 1762	Scheibe Washer / Rondelle	ACTROS/AXOR SK/MK/NG

KTK No.	RF No.	Bezeichnung Description Désignation	Erläuterungen Remarks Remarques
07929	 4 057822 079291	355 350 0128	Spinne Spider / Araignée
			
10058	 4 057822 100582	020 997 3947	Wellendichtring Oil seal Bague d'etanchéité
			145x175x17 ACTROS SK/MK/NG
10078	 4 057822 100780	009 997 5246	Wellendichtring Oil seal Bague d'etanchéité
			143x165x10 SK/MK/NG
15829	 4 057822 158293	020 997 0647	Wellendichtring Oil seal Bague d'etanchéité
			75x105x19 ACTROS/AXOR ATEGO
12586	 4 057822 125868	015 997 4747 346 353 0458	Wellendichtring Oil seal Bague d'etanchéité
			85x145x12/37 ACTROS/AXOR ATEGO















KTK No.	RF No.	Bezeichnung Description Désignation	Erläuterungen Remarks Remarques
12289	 4 057822 122898		
		346 353 0124	Scheibe Washer / Rondelle
12290	 4 057822 122904		
		346 353 2551	Scheibe Washer / Rondelle
12112	 4 057822 121129		
		387 586 9950	Reparatursatz Repair kit Kit de réparation  For differential spider 346 353 0420 SK/MK/NG
14298	 4 057822 142988		
		355 353 9850	Reparatursatz Repair kit Kit de réparation
14299	 4 057822 142995		
		346 353 9850	Reparatursatz Repair kit Kit de réparation

















KTK No.	RF No.	Bezeichnung Description Désignation	Erläuterungen Remarks Remarques
06517	 4 057822 065171	  002 990 8201 CPL Bolzen mit Mutter Bolt with nut Jeu d'axes 10.9 M12 x 1.5 x 30	302, 309, 335 343, 346, 352, 353, 360, 380, 381, 383, 385
06518	 4 057822 065188	  002 990 8401 CPL Bolzen mit Mutter Bolt with nut Jeu d'axes 10.9 M14 x 1.5 x 38	335, 336, 346, 363
06516	 4 057822 065164	  002 990 9901 CPL Bolzen mit Mutter Bolt with nut Jeu d'axes 10.9 M16 x 1.5 x 45	343, 346, 352, 353, 381, 383, 387, 389, 393, 395, 624, 656















KTK No.	RF No.	Bezeichnung Description Désignation	Erläuterungen Remarks Remarques
08665	 4 057822 086657	 001 981 7605 Rollenlager Wheel bearing Palier à rouleaux Front axle, Outer	Actros/Axor 50x110x42
08666	 4 057822 086664	 004 981 9805 Rollenlager Wheel bearing Palier à rouleaux	Actros/Atego 70x150x54
08667	 4 057822 086671	 003 981 6805 004 981 0305 Rollenlager Wheel bearing Palier à rouleaux	343/371/386/395/397 398/ 624/625/649/659 696 105x170x40
10872	 4 057822 108724	 000 980 9702 Rollenlage Wheel bearing Palier à rouleaux	105x160x43 Actros/Axor Rear small
09046	 4 057822 090463	 001 980 2702 Rollenlager Wheel bearing Palier à rouleaux	LK/MK/NG 75x130x41











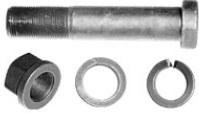



KTK No.	RF No.	Bezeichnung Description Désignation	Erläuterungen Remarks Remarques
10873	 4 057822 108731		
		001 980 2602	Rollenlage Wheel bearing Palier à rouleaux
95x145x32  LK/MK/NG			
10874	 4 057822 108748		
		003 981 3205	Rollenlage Wheel bearing Palier à rouleaux
349/740/746/748  75x125x37			
10875	 4 057822 108755		
			Rollenlage Bearing Palier à rouleaux
60x110x22			
10117	 4 057822 101176		
		004 981 2405	Rollenlager Wheel bearing Palier à rouleaux
70x130x57			
10118	 4 057822 101183		
		004 981 0705 005 981 2105 008 981 3505	Rollenlager Wheel bearing Palier à rouleaux
110x170x38 ACTROS/AXOR Rear axle inner			

KTK No.	RF No.	Bezeichnung Description Désignation	Erläuterungen Remarks Remarques	
10119	 4 057822 101190			
		004 981 2105	Rollenlager Wheel bearing Palier à rouleaux	100x180x37 LK/SK
11432	 4 057822 114329			
		006 981 6305	Rollenlager Wheel bearing Palier à rouleaux	ATEGO/LK/SK 65x120x41
12078	 4 057822 120788			
		004 981 1705	Rollenlager Wheel bearing Palier à rouleaux	ATEGO/LK 90x140x32/35
17604	 4 057822 176044			
		007 981 7005 011 981 0805	Rollenlager Wheel bearing, inner Palier à rouleaux	85x150x49/52 Actros
17656	 4 057822 176563			
		011 981 6805 011 981 6905 015 981 7505	Rollenlager Wheel bearing, outer Palier à rouleaux	60x130x48 Actros

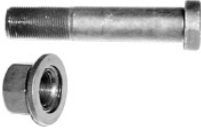
KTK No.		RF No.	Bezeichnung Description Désignation	Erläuterungen Remarks Remarques
19227	 4 057822 192273	016 981 2805 000 330 0725 014 981 5105 014 981 9305 014 981 9905 017 981 5005	Radlagereinheit Wheel bearing Unité de palier de roue	Atego Rear axle
22854	 4 057822 228548	001 980 0502	Radlagereinheit Bearing Unité de palier de roue	
22856	 4 057822 228569	014 981 2205	Radlagereinheit Bearing Unité de palier de roue	
22855	 4 057822 228552	001 981 6405	Radlagereinheit Wheel Bearing Unité de palier de roue	
22857	 4 057822 228576	014 981 2005	Radlagereinheit Wheel Bearing Unité de palier de roue	







KTK No.	RF No.	Bezeichnung Description Désignation	Erläuterungen Remarks Remarques
18869	 4 057822 188695		
		Rollenlage Bearing With cover Palier à rouleaux	60x110x22
13254	 4 057822 132546		
		004 981 9805 Rollenlage Wheel bearing Palier à rouleaux	70x150x54/58 Actros/Axor/Atego
11431	 4 057822 114316		
		Rollenlage Bearing Palier à rouleaux	70x125x24















KTK No.	RF No.	Bezeichnung Description Désignation	Erläuterungen Remarks Remarques
09110	 4 057822 091101		
		074 361 022 205 Radmutter Wheel nut Ecrou de roue	SW30, M22x1.5 ACTROS/AXOR L series SK/MK/NG
09114	 4 057822 091149		
		317 402 0175 Scheibe Washer Rondelle	L series SK/MK/NG ACTROS/AXOR
09115	 4 057822 091156		
		074 361 022 351 074 361 022 352 Scheibe Washer Rondelle	ACTROS/AXOR L series SK/MK/NG
09111	 4 057822 091118		
		389 401 0071 cpl Reparatursatz Repair kit Kit de réparation Front	09114 - 1Nos. 09115 - 1Nos. M22x1.5 - L = 80
11850	 4 057822 118501		
		389 401 0071 Radbolzen Wheel bolt Goujon de roue	ACTROS/AXOR L series SK/MK/NG





KTK No.	RF No.	Bezeichnung Description Désignation	Erläuterungen Remarks Remarques
09113	381 401 0771 N	Reparatursatz Repair kit Kit de réparation	09114 - 1Nos. 09115 - 1Nos. 09110 - 1Nos. SK/MK/NG Rear ACTROS/AXOR L series M22x1.5 - L = 110
	 4 057822 091132		
11849	381 401 0771	Radbolzen Wheel bolt Goujon de roue	SK/MK/NG L series ACTROS/AXOR
	 4 057822 118495		
08818	385 400 0124	Radmutter Wheel Nut Ecrou de roue L series	SW32, M22x1.5 SK/MK/NG ACTROS/AXOR
	 4 057822 088187		
09112	381 401 0771 cpl	Reparatursatz Repair kit Kit de réparationL	08818 - 1Nos. Rear L = 110 L series SK/MK/NG ACTROS/AXOR
	 4 057822 091125		
18010	381 401 0771A	Bolzen mit Mutter Bolt with nut Jeu d'axes	ACTROS L = 110 M22x1.5
	 4 057822 180102		

































KTK No.	RF No.	Bezeichnung Description Désignation	Erläuterungen Remarks Remarques
14308			
	 4 057822 143084  	942 401 0271 Bolzen mit Mutter Hub bolt with nut Jeu d'axes	L = 79 mm ACTROS M22x1.5
14309			
	 4 057822 143091  	942 401 0371 Bolzen mit Mutter Hub bolt with nut Jeu d'axes	L = 101mm ACTROS M22x1.5
18511			
	 4 057822 185114  	315 402 0170 346 402 5070 Bolzen mit Mutter Bolt with nut Jeu d'axes	125x18x2
18512			
	 4 057822 185121  	620 401 0170 Bolzen mit Mutter Bolt with nut Jeu d'axes	115x20x2
19074			
	 4 057822 190743  	620 401 0700 Bolzen mit Mutter Bolt with nut Jeu d'axes	Actros/Axor 57x20x2

KTK No.	RF No.	Bezeichnung Description Désignation	Erläuterungen Remarks Remarques
20573			
 4 057822 205737			
 	345 401 0070	Bolzen mit Mutter Hub bolt with nut Jeu d'axes	20x2x130
20574			
 4 057822 205744			
 	620 402 0068	Klemmstück Clamping piece Pièce de serrage	SK/MK/NG















KTK No.	RF No.	Bezeichnung Description Désignation	Erläuterungen Remarks Remarques
10151			
	 <p>4 057822 101510</p> 	385 410 0231 Zapfenkreuz Universal joint cross Croisillon	38x56mm L series
10153			
	 <p>4 057822 101534</p> 	385 410 0131 Zapfenkreuz Universal joint cross Croisillon	42x66mm L series
10156			
	 <p>4 057822 101565</p> 	381 410 0531 381 410 0231 Zapfenkreuz Universal joint cross Croisillon	48x126mm LK SK/MK/NG
10155			
	 <p>4 057822 101558</p> 	304 410 0031 Zapfenkreuz Universal joint cross Croisillon	45x120mm L series
10164			
	 <p>4 057822 101640</p> 	335 410 0031 Zapfenkreuz Universal joint cross Croisillon	52.03x133mm L series

KTK No.	RF No.	Bezeichnung Description Désignation	Erläuterungen Remarks Remarques
10165	 4 057822 101657	363 410 0631 620 410 0131	Zapfenkreuz Universal joint cross Croisillon  53x135mm L series SK/MK/NG
10166	 4 057822 101664	387 410 0031 620 410 0031	Zapfenkreuz Universal joint cross Croisillon  57x152mm L series SK/MK/NG
10167	 4 057822 101671	656 410 0031 656 410 0131 942 410 0031	Zapfenkreuz Universal joint cross Croisillon  68x166mm ACTROS/AXOR SK/MK/NG
13258	 4 057822 132583	645 410 0131	Zapfenkreuz Universal joint cross Croisillon  65x172mm SK/MK/NG
15758	 4 057822 157586	Zapfenkreuz Universal joint cross Croisillon	SK/MK/NG 48x116.50















KTK No.	RF No.	Bezeichnung Description Désignation	Erläuterungen Remarks Remarques
08903			
	 4 057822 089030  	385 586 0141 385 410 0922 385 410 0122 385 410 0110 385 410 0222 Gummilager Central rubber bearing Silentbloc	55mm $\varnothing$ SK/MK/NG
08899			
	 4 057822 088996  	389 410 0122 389 410 0222 654 410 00 22 Gummilager Central rubber bearing Silentbloc	60mm $\varnothing$ L series SK/MK/NG
10120			
	 4 057822 101206  	363 410 0151 Ausrücklager Bearing Palier à rouleaux	L series SK/MK/NG
07734			
	 4 057822 077341  	363 413 0012 Gummilager Rubber mounting Silentbloc	343, 346, 383, 385, 387, 389 393, 395, 397, 624 L series SK/MK/NG
08900			
	 4 057822 089009  	395 410 0622 395 410 0022 620 410 0010 Gummilager Central rubber bearing Silentbloc	70mm $\varnothing$ ACTROS/AXOR L series SK/MK/NG















KTK No.	RF No.	Bezeichnung Description Désignation	Erläuterungen Remarks Remarques
07733			
	 4 057822 077334  	338 413 0012  Gummilager Rubber mounting Silentbloc	335, 343, 346 L series 115x92x40
12090			
	 4 057822 120900  	363 410 0051  Rollenlager / Bearing Palier à rouleaux	L series - $\varnothing$ 55 336/338 343/346/349 352/355 360/363
11760			
	 4 057822 117603  	903 410 0010 901 410 0312  Gummilager Central rubber bearing Silentbloc	Transporter 45x19 $\varnothing$ L series
13717			
	 4 057822 137175  	656 411 0012  Gummilager Central rubber bearing Silentbloc	70x20 $\varnothing$
13718			
	 4 057822 137182  	659 411 0112  Gummilager Central rubber bearing Silentbloc	80x22 $\varnothing$ ACTROS 930/932/933 950/952/953





KTK No.	RF No.	Bezeichnung Description Désignation	Erläuterungen Remarks Remarques
13719			
			
	654 411 0012	Gummilager Central rubber bearing Silentbloc	60x22 ⌀ 950- ACTROS 970/976-ATEGO
13720			
			
	973 411 0012 973 411 0112	Gummilage Central rubber bearing Silentbloc	55x23 ⌀ 950/952-ACTROS 970/972/974/ 976 - ATEGO













KTK No.	RF No.	Bezeichnung Description Désignation	Erläuterungen Remarks Remarques
11117			
 4 057822 111175  	001 420 5283	Reparaturatz Repair kit Kit de réparation	ACTROS
07737			
 4 057822 077372  	395 420 0082 307 420 4102 395 586 0242	Reparaturatz Repair kit brake shoe Kit de réparation	1626, 1632, 1926, 1932 2626, 2632, 1921, 1928, 2628, 3328 L series SK/MK/NG
22590			
 4 057822 225906  	497 421 0074	Brake shoe pin	
07740			
 4 057822 077402  	307 421 0550	Buchse Bushing / Bague	
07739			
 4 057822 077396  	346 994 0109	Sicherungsblech Lock plate Tôle de fixation	













KTK No.	RF No.	Bezeichnung Description Désignation	Erläuterungen Remarks Remarques
06526			
 <p>4 057822 065263</p>			
 	346 420 1738	Gestängesteller Slack adjuster Lever régléur	L = 161 LH MK/SK/NG Rear axle
06527			
 <p>4 057822 065270</p>			
 	346 420 1838	Gestängesteller Slack adjuster Lever régléur	L = 161 RH
06642			
 <p>4 057822 066420</p>			
 	617 420 0338	Gestängesteller, automatisch Automatic Slack adjuster Lever régléur, automatique	LH ACTROS AXOR ATEGO SK/MK/NG
06643			
 <p>4 057822 066437</p>			
 	617 420 0438	Gestängesteller, automatisch Automatic Slack adjuster Lever régléur, automatique	RH ACTROS AXOR ATEGO SK/MK/NG
17085			
 <p>4 057822 170851</p>			
 	000 420 0092	Reparatursatz Repair kit Kit de réparation SK/MK/NG	ACTROS AXOR ATEGO









KTK No.	RF No.	Bezeichnung Description Désignation	Erläuterungen Remarks Remarques
06551	 4 057822 065515		
		617 420 0238	Gestängesteller, automatisch Automatic Slack adjuster Levier régleur, automatique  LH & RH SK/MK/NG
06644	 4 057822 066444		
		652 420 0038	Gestängesteller, automatisch Automatic Slack adjuster Levier régleur, automatique  LH ACTROS AXOR/ATEGO SK/MK/NG
08647	 4 057822 086473		
		652 420 0138	Gestängesteller, automatisch Automatic Slack adjuster Levier régleur, automatique  RH ACTROS AXOR/ATEGO SK/MK/NG
06645	 4 057822 066451		
		652 420 0238	Gestängesteller, automatisch Automatic Slack adjuster Levier régleur, automatique  SK/MK/NG 740/747/748
19221	 4 057822 192211		
		945 420 0038	Gestängesteller, automatisch Slack adjuster, automatic Levier régleur, automatique  (Blue colour) LH Actros/Atego Axor













KTK No.	RF No.	Bezeichnung Description Désignation	Erläuterungen Remarks Remarques
19222	 4 057822 192228	945 420 0138	Gestängesteller, automatisch (Blue colour) RH Slack adjuster, automatic Actros/Atego Levier régleur, automatique Axor
19223	 4 057822 192235	945 420 0238	Gestängesteller, automatisch (Blue colour) LH Slack adjuster, automatic Actros/Atego Levier régleur, automatique Axor
19224	 4 057822 192242	945 420 0338	Gestängesteller, automatisch (Blue colour) RH Slack adjuster, automatic Actros/Atego Levier régleur, automatique Axor
19225	 4 057822 192259	945 420 0438	Gestängesteller, automatisch (Blue colour) RH Slack adjuster, automatic Actros/Atego Levier régleur, automatique Axor
19226	 4 057822 192266	945 420 0938	Gestängesteller, automatisch (Blue colour) LH Slack adjuster, automatic Actros/Atego Levier régleur, automatique Axor

KTK No.	RF No.	Bezeichnung Description Désignation	Erläuterungen Remarks Remarques
08546	 4 057822 085469		
  	623 423 0136 346 423 1136	Bremsnockenwelle, links Camshaft LH Arbre á came de frein, gauche	Rear axle SK/MK/NG L = 545
08547	 4 057822 085476		
  	623 423 0236 346 423 1236	Bremsnockenwelle, rechts Camshaft RH Arbre á came de frein, droite	
16853	 4 057822 168537		
  	389 421 0136 623 421 0136	Bremsnockenwelle, links Camshaft LH Arbre á came de frein, gauche	Front L = 255 SK/MK/NG
16854	 4 057822 168544		
  	389 421 0236 623 421 0236	Bremsnockenwelle, rechts Camshaft RH Arbre á came de frein, droite	















KTK No.	RF No.	Bezeichnung Description Désignation	Erläuterungen Remarks Remarques
07741	 4 057822 077419	Membrane Diaphragm	T 9 L series/SK/MK/NG
07742	 4 057822 077426	000 431 1728 Membrane Diaphragm	T 12
07743	 4 057822 077433	000 421 2986 Membrane Diaphragm	T 16
07744	 4 057822 077440	000 431 0728 Membrane Diaphragm	T 20
07745	 4 057822 077457	000 421 2086 Membrane Diaphragm	T 24















KTK No.	RF No.	Bezeichnung Description Désignation	Erläuterungen Remarks Remarques
07746			
	 4 057822 077464		
		000 423 1286 Membrane Diaphragm	T 30
07747			
	 4 057822 077471		
		Membrane Diaphragm	T 36









KTK No.	RF No.	Bezeichnung Description Désignation	Erläuterungen Remarks Remarques
07748			
	 4 057822 077488	000 431 2028 000 431 2128  Membrane - lang Diaphragm long stroke Membrane - longue	T 16
07749			
	 4 057822 077495	000 421 4286  Membrane - lang Diaphragm long stroke Membrane - longue	T 20
07750			
	 4 057822 077501	000 423 3486 000 431 1928  Membrane - lang Diaphragm long stroke Membrane - longue	T 24
07751			
	 4 057822 077518	000 421 6286  Membrane - lang Diaphragm long stroke Membrane - longue	T 30

KTK No.	RF No.	Bezeichnung Description Désignation	Erläuterungen Remarks Remarques
06554	 4 057822 065546		
		303 993 0410	Feder Spring / Ressort
06562	 4 057822 065621		
		346 993 0310	Feder Spring / Ressort
06561	 4 057822 065614		
		346 993 0210	Feder Spring / Ressort
15041	 4 057822 150419		
		346 993 0810	Feder Spring / Ressort



KTK No.	RF No.	Bezeichnung Description Désignation	Erläuterungen Remarks Remarques
20703	 4 057822 207038		
		004 429 8744 Ventil 004 429 8844 Solenoid valve, ABS 005 429 3044 Soupape	
20704	 4 057822 207045		
		000 760 0378 Ventil 000 763 2552 Solenoid valve Soupape	
10249	 4 057822 102494		
		000 429 1431 Ventil 000 429 0631 Valve Soupape	L series SK/MK/NG
10910	 4 057822 109103		
		002 429 8744 Ventil Air valve Soupape	SK/MK/NG
10917	 4 057822 109172		
		002 429 9244 Ventil 002 429 9344 Relay valve 002 429 9444 Soupape	SK/MK/NG

KTK No.	RF No.	Bezeichnung Description Désignation	Erläuterungen Remarks Remarques
07333			
	 4 057822 073336  	000 429 6544 Ventil 003 429 5244 Relay valve 001 429 3044 Soupape	Thread 1 : M22x1.5 Thread 2 : M22x1.5 301/307/321/328 343/344/345/346/ 349/350/352/355 360/363
07334			
	 4 057822 073343  	001 429 6844 Ventil 000 429 3044 Relay valve 002 429 8444 Soupape	Thread 1: M22x1.5 Thread 2: M16x1.5 LK/SK/MK/NG
20682			
	 4 057822 206826  	004 429 0644 Ventil 004 429 1144 Relay Valve Soupape	
09813			
	 4 057822 098131  	005 429 1044 Ventil Air Valve Soupape	ACTROS 3331/3340 3343/3348
07338			
	 4 057822 073381  	000 429 4144 Ventil 000 429 0644 Quick release valve 000 429 2544 Soupape	SK/MK/NG

KTK No.	RF No.	Bezeichnung Description Désignation	Erläuterungen Remarks Remarques
12257	 4 057822 122577		
		001 429 2444	Ventil Valve Soupape
12256	 4 057822 122560		
		000 429 1795 000 429 2995	Ventil Air valve Soupape  20 bar
12266	 4 057822 122669		
		001 429 5244 001 429 7944 001 429 9244 001 429 9844 003 429 0244	Ventil valve Soupape

KTK No.	RF No.	Bezeichnung Description Désignation	Erläuterungen Remarks Remarques
---------	--------	---	---------------------------------------

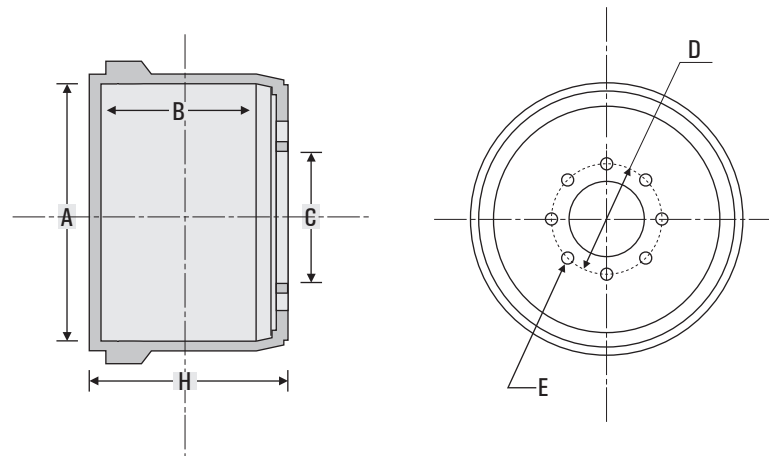

**07970**



**305 421 0401** Bremstrommel  
Brake drum - Front  
tambour de frein

A = 410mm  
B = 167mm  
H = 213mm  
C = 298mm  
D = 335mm  
E = 23xM12  
10 Hole

**07971**



**305 423 0401** Bremstrommel  
Brake drum rear  
Tambour de frein

A = 410mm  
B = 239mm  
H = 306mm  
C = 298mm  
D = 335mm  
E = 23xM12  
10 Hole

**07972**



**346 423 0501** Bremstrommel  
**346 423 0101** Brake drum rear  
Tambour de frein

A = 410mm  
B = 192mm  
H = 280mm  
C = 298mm  
D = 335mm  
E = 24xM12  
10 Hole

KTK No.	RF No.	Bezeichnung Description Désignation	Erläuterungen Remarks Remarques
---------	--------	---	---------------------------------------

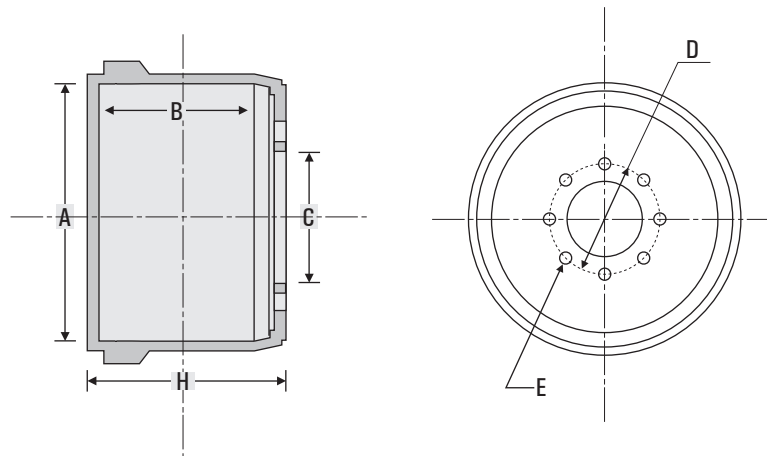

**07973**



346 423 0601 Bremstrommel  
346 423 0001 Brake drum rear  
Tambour de frein

A = 410mm  
B = 172mm  
H = 270mm  
C = 298mm  
D = 335mm  
E = 24xM12  
10 Hole

**09015**



624 421 0201 Bremstrommel  
642 421 0201 Brake drum  
Tambour de frein

A = 410mm  
B = 191mm  
H = 237mm  
C = 298mm  
10 Hole

**12407**













658 421 0001 Bremstrommel  
Brake drum front  
tambour de frein















A = 410mm  
B = 191mm  
H = 237mm  
C = 298mm  
D = 335mm  
E = 23  
10 Hole















KTK No.	RF No.	Bezeichnung Description Désignation	Erläuterungen Remarks Remarques
15540			
	 4 057822 155407		
		942 421 2112 Bremsscheibe 942 421 1112 Brake disc 942 421 1212 frein à disque	ACTROS/AXOR ⌀ 430
19341			
	 4 057822 193416		
		943 421 0312 Bremsscheibe Brake disc frein à disque	ACTROS/AXOR ⌀ 430 Front Axle









KTK No.	RF No.	Bezeichnung Description Désignation	Erläuterungen Remarks Remarques
12091			
	 <p>4 057822 120917</p> 	<p>002 420 4920 000 421 0510 003 420 1020</p> <p>Scheibenbremsbelagsatz Brake pad set Kit de garnitures de frein à disques</p>	<p>ACTROS/AXOR SK/MK/NG</p>
16364			
	 <p>4 057822 163648</p> 	<p>000 421 0810 000 421 0710 000 421 5010 002 420 7820 002 420 7828</p> <p>Scheibenbremsbelagsatz Brake pad set Kit de garnitures de frein à disques</p>	<p>ATEGO</p>
19632			
	 <p>4 057822 196325</p> 	<p>006 420 1420 006 420 5220</p> <p>Scheibenbremsbelagsatz Brake pad set Kit de garnitures de frein à disques</p>	<p>Actros MP2/3/4</p>
19994			
	 <p>4 057822 199944</p> 	<p>006 420 5320 006 420 1520</p> <p>Scheibenbremsbelagsatz Brake pad set Kit de garnitures de frein à disques</p>	<p>MP2</p>













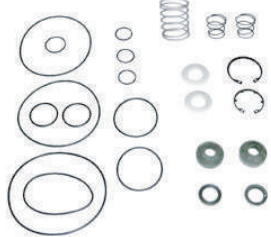

KTK No.	RF No.	Bezeichnung Description Désignation	Erläuterungen Remarks Remarques
<p><b>08251</b></p>  <p>4 057822 082512</p> 	<p>000 420 7424 000 420 7524 001 420 3524</p>	<p>Federspeicherbremszylinder Brake Booster Cylindre de frein à ressort accumulateur</p>	<p>24"</p>
<p><b>08252</b></p>  <p>4 057822 082529</p> 	<p>000 420 8024</p>	<p>Federspeicherbremszylinder Brake Booster Cylindre de frein à ressort accumulateur</p>	<p>30"</p>
<p><b>08974</b></p>  <p>4 057822 089740</p> 	<p>006 420 1118 006 420 3918 006 420 5618</p>	<p>Federspeicherbremszylinder 16/24 Brake Booster Cylindre de frein à ressort accumulateur</p>	
<p><b>13307</b></p>  <p>4 057822 133078</p> 		<p>Federspeicherbremszylinder Brake Booster Cylindre de frein à ressort accumulateur</p>	<p>24"/24"</p>
<p><b>13308</b></p>  <p>4 057822 133085</p> 		<p>Federspeicherbremszylinder Brake Booster Cylindre de frein à ressort accumulateur</p>	<p>30"/24"</p>

























KTK No.		RF No.	Bezeichnung Description Désignation	Erläuterungen Remarks Remarques
12267	 4 057822 122676			
		006 420 5318	Federspeicherbremszylinder Brake Booster Cylindre de frein à ressort accumulateur	30/30
21597	 4 057822 215972			
		012 420 0018 013 420 4718	Federspeicherbremszylinder Brake Booster Cylindre de frein à ressort accumulateur	16/24
21598	 4 057822 215989			
		012 420 7318	Federspeicherbremszylinder Brake Booster Cylindre de frein à ressort accumulateur	
21599	 4 057822 215996			
		018 420 5318	Federspeicherbremszylinder Brake Booster Cylindre de frein à ressort accumulateur	
21600	 4 057822 216009			
		015 420 4318 021 420 9518	Federspeicherbremszylinder Brake Booster Cylindre de frein à ressort accumulateur	



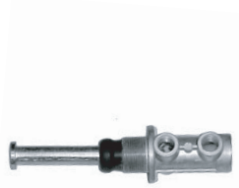











KTK No.	RF No.	Bezeichnung Description Désignation	Erläuterungen Remarks Remarques
21601			
 4 057822 216016			
 	015 420 4418 019 420 6418	Federspeicherbremszylinder Brake Booster Cylindre de frein à ressort accumulateur	
21602			
 4 057822 216023			
 	015 420 7518 015 420 8518 020 420 3318	Federspeicherbremszylinder Brake Booster Cylindre de frein à ressort accumulateur	
23757			
 4 057822 237578			
 	019 420 7718	Federspeicherbremszylinder Brake Booster Cylindre de frein à ressort accumulateur	24/24 Actros
23758			
 4 057822 237585			
 	019 420 7818	Federspeicherbremszylinder Brake Booster Cylindre de frein à ressort accumulateur	24/24 Atego
23759			
 4 057822 237592			
 	019 420 8118	Federspeicherbremszylinder Brake Booster Cylindre de frein à ressort accumulateur	30/30 Actros

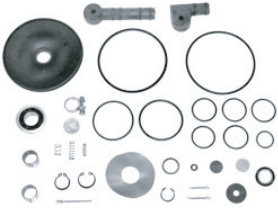













KTK No.	RF No.	Bezeichnung Description Désignation	Erläuterungen Remarks Remarques
23760			
 4 057822 237608			
 	019 420 8218	Federspeicherbremszylinder Brake Booster Cylindre de frein à ressort accumulateur	30/30 Actros
23761			
 4 057822 237615			
 	016 420 4118 018 420 1718 019 420 9218	Federspeicherbremszylinder Brake Booster Cylindre de frein à ressort accumulateur	24/24
23762			
 4 057822 237578			
 	019 420 9118 016 420 1418 018 420 1618	Federspeicherbremszylinder Brake Booster Cylindre de frein à ressort accumulateur	24/24

KTK No.	RF No.	Bezeichnung Description Désignation	Erläuterungen Remarks Remarques
07787	 4 057822 077877		
		000 432 0807 Entwässerungsventil 000 432 0607 Drain Valve 000 432 1107 Valve de purge d'eau 000 432 2007	M22 x 1.5mm SW27mm ACTROS SK/MK/NG
08954	 4 057822 089542		
		000 586 8643 Reparatursatz Repair kit Kit de réparation	For Valve 001 431 3505 L / SK/MK/NG
11107	 4 057822 111076		
		Ventil Air valve Soupape	
13325	 4 057822 133252		
		004 431 4605 Ventil 004 431 5905 Air valve Soupape	ACTROS AXOR ATEGO
13326	 4 057822 133269		
		003 431 2205 Ventil 003 431 1705 Air valve 003 431 2805 Soupape 003 431 3205	SK/MK/NG ACTROS





KTK No.	RF No.	Bezeichnung Description Désignation	Erläuterungen Remarks Remarques
07324			
 4 057822 073244    	 001 431 8305 001 431 8905 002 431 2705	 Ventil Foot Brake Valve Soupape	 NG 1628 S/LS
08938			
 4 057822 089386    	 001 430 0460	 Reparaturatz Repair kit Kit de réparation	
11120			
 4 057822 111205    	 002 431 0605	 Ventil Air valve Soupape	 NG 1628 L 1636 L 1928 L
08941			
 4 057822 089412    		 Reparaturatz Repair kit Kit de réparation	
08940			
 4 057822 089405    	 000 430 3006	 Reparaturatz Repair kit Kit de réparation	 For Valve 003 431 1805 SK/MK/NG







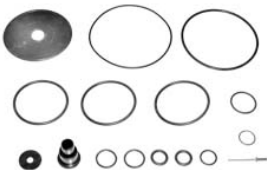







KTK No.	RF No.	Bezeichnung Description Désignation	Erläuterungen Remarks Remarques	
11110				
	 4 057822 111106	003 431 5406 003 431 5706	Ventil Air Valve Soupape	ACTROS
07339				
	 4 057822 073398	000 434 0601 000 430 0509 000 434 2401	Ventil Air valve Soupape	L series 352/353/360
10071				
	 4 057822 100711	000 434 2301	Ventil Air valve Soupape	OM 402/422 L series SK/MK/NG
11454				
	 4 057822 114541	000 434 3801	Ventil Air valve Soupape	SK/MK/NG





KTK No.	RF No.	Bezeichnung Description Désignation	Erläuterungen Remarks Remarques
<p><b>07328</b></p>  <p>4 057822 073282</p>  	<p>001 431 8112 001 431 8212 001 431 3312</p>	<p>Ventil Automatic load sensing valve Soupape</p>	<p>SK/MK/NG</p>
<p><b>07329</b></p>  <p>4 057822 073299</p>  	<p>001 431 8312 001 431 8112 001 431 8212</p>	<p>Ventil Automatic load sensing valve Soupape</p>	<p>SK/MK/NG</p>
<p><b>08948</b></p>  <p>4 057822 089481</p>  	<p>000 430 7560 003 586 0243</p>	<p>Reparaturatz Repair kit Kit de réparation</p>	
<p><b>08949</b></p>  <p>4 057822 089498</p>  		<p>Reparaturatz Repair kit Kit de réparation</p>	
<p><b>11113</b></p>  <p>4 057822 111137</p>  	<p>002 431 2406</p>	<p>Ventil Air valve Soupape</p>	<p>SK/MK/NG</p>





KTK No.	RF No.	Bezeichnung Description Désignation	Erläuterungen Remarks Remarques
08953	 4 057822 089535		
		000 430 4960	Reparatursatz Repair kit Kit de réparation
07327	 4 057822 073275		
		002 431 4006 001 431 0106 002 431 0206	Ventil Circuit valve Soupape
07326	 4 057822 073268		
		001 431 8706 002 431 0106	Ventil Circuit protection valve Soupape
07336	 4 057822 073367		
		001 430 0281 001 430 0981 001 430 1681	Ventil Hand brake valve Soupape
07337	 4 057822 073374		
		002 430 7881 002 430 7481	Ventil Hand brake valve Soupape







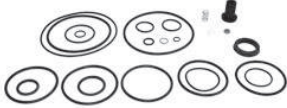









KTK No.	RF No.	Bezeichnung Description Désignation	Erläuterungen Remarks Remarques
10911			
	000 430 8581	Ventil Air valve Soupape	NG series
10913			
	001 997 5036 001 997 6136	Ventil Air valve Soupape	LP
07331			
	001 431 3705 001 431 1805 001 431 2805 002 431 2805	Ventil Control valve Soupape	NG 427/447
08942			
	001 586 6043 002 430 6581	Reparaturatz Repair kit Kit de réparation	
07332			
	001 431 6905 001 431 6705 002 431 4005 002 431 4805	Ventil Control valve Soupape	LK/NG 385/625/684

KTK No.	RF No.	Bezeichnung Description Désignation	Erläuterungen Remarks Remarques
08943			
 4 057822 089436  	 002 430 1860 002 586 9343	 Reparaturatz Repair kit Kit de réparation	
08253			
 4 057822 082536  	 001 431 0006 001 431 0606 001 431 3406	 Ventil NG Unloader valve Soupape	 1628/1633/1636
08936			
 4 057822 089368  	 000 430 1107 001 586 4343	 Reparaturatz Repair kit Kit de réparation	
07322			
 4 057822 073220  	 002 431 4906 002 431 8306 001 431 3406	 Ventil Unloader valve Soupape	 L series SK/MK/NG
07321			
 4 057822 073213  	 002 431 4606 002 431 1506 002 431 5206 002 431 8706	 Ventil Unloader valve Soupape	 SK/NG

KTK No.	RF No.	Bezeichnung Description Désignation	Erläuterungen Remarks Remarques
08937			
	001 430 4960	Reparatursatz Repair kit Kit de réparation	
07335			
		Ventil Valve Soupape	
11108			
	000 430 9581 001 430 3682 001 430 3681	Ventil Air Valve Soupape	NG 1628 1636 1928
12258			
	000 430 2070	Silencer	
12255			
	000 430 7881	Ventil Air valve Soupape	

KTK No.	RF No.	Bezeichnung Description Désignation	Erläuterungen Remarks Remarques
12250			
	 	003 431 8205 Ventil 003 431 1305 Air valve 003 431 3405 Soupape	LK/MK/SK
12251			
	 	000 430 3706 Reparatursatz Repair kit Kit de réparation	

KTK No.	RF No.	Bezeichnung Description Désignation	Erläuterungen Remarks Remarques
11455	 4 057822 114558		
		001 431 7815 001 431 8115	Lufttrocknerpatrone mit Ventil    ACTROS Air filter with valve                1831/2031/2053 Cartouche de déssiccateur avec soupape
12341	 4 057822 123413		
			Ventil Air valve    12335 Soupape
12336	 4 057822 123369		
			Lufttrocknerpatrone mit Ventil Air filter with valve Cartouche de déssiccateur avec soupape
12342	 4 057822 123420		
			Ventil Air valve Soupape
12335	 4 057822 123352		
		000 431 2215 001 431 0415 001 431 0715 001 431 0717 001 431 2215	Lufttrocknerpatrone mit Ventil    LK/MK/SK Air filter with valve Cartouche de déssiccateur avec soupape

KTK No.	RF No.	Bezeichnung Description Désignation	Erläuterungen Remarks Remarques
---------	--------	---	---------------------------------------

10248



000 429 3795

Lufttrocknerpatrone

ACTROS/AXOR

000 430 0969

Air Filter

SK/MK/NG

000 429 3795

Cartouche de déssiccateur

09606

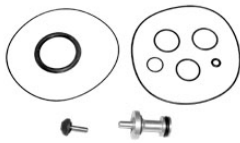

Reparaturatz

Knorr type

Air drayer repair kit

Kit de réparation

19792



000 431 3615













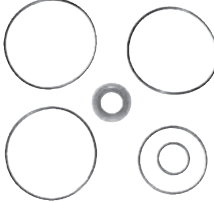

Lufttrocknerpatrone















000 431 3715

Air dryer

000 431 6515

Cartouche de déssiccateur

KTK No.	RF No.	Bezeichnung Description Désignation	Erläuterungen Remarks Remarques
12264			
 4 057822 122645			
 		000 466 6701 Lenkhelfpumpe 000 460 2480 Steering pump 000 460 6680 Pompe de direction assistée 000 460 6080	LK/MK/SK/NG 100 MPA
09762			
 4 057822 097622			
 		000 586 2846 Reparatursatz Repair kit Kit de réparation	1924, 2624
12263			
 4 057822 122638			
 		002 460 6780 001 460 7080 Lenkhelfpumpe Steering pump Pompe de direction assistée	120 MPA SK/MK/NG
15173			
 4 057822 151737			
 		002 460 0880 002 460 3980 001 460 3080 Lenkhelfpumpe Steering pump Pompe de direction assistée	ACTROS 180 BAR
22106			
 4 057822 221065			
 		002 460 8880 002 460 8980 003 460 2280 Lenkhelfpumpe Steering pump Pompe de direction assistée	ACTROS

KTK No.	RF No.	Bezeichnung Description Désignation	Erläuterungen Remarks Remarques
09764	 4 057822 097646		
		366 586 5446 Reparatursatz Repair kit Kit de réparation	
10987	 4 057822 109875		
		011 997 7246 003 997 2647 014 997 6947 Wellendichtring Oil seal Bague d'etanchéité	28x40x8/6
10988	 4 057822 109882		
		Wellendichtring Oil seal Bague d'etanchéité	54.8X70X9/7
22726	 4 057822 227265		
		003 460 5180 Lenkhelfpumpe Steering pump Pompe de direction assistée	ACTROS
23144	 4 057822 231446		
		001 466 7501 Lenkhelfpumpe Steering pump Pompe de direction assistée	



<b>KTK No.</b>	<b>RF No.</b>	<b>Bezeichnung Description Désignation</b>	<b>Erläuterungen Remarks Remarques</b>
----------------	---------------	--	--

22793



4 057822 227937



000 430 1380  
001 460 7080

Lenkhelfpumpe  
Steering pump  
Pompe de direction assistée

KTK No.	RF No.	Bezeichnung Description Désignation	Erläuterungen Remarks Remarques
08180			
 4 057822 081805	343 997 0582 385 997 1682	Schlauch Steering hose Durite	L series
 			
08179			
 4 057822 081799	360 997 0982 385 997 1582	Schlauch Steering hose Durite	L series
 			
14307			
 4 057822 143077	000 997 8152 001 997 6352 012 997 2482	Schlauch Steering hose Durite	SK/MK/NG
 			
21908			
 4 057822 219086	942 466 0481 942 466 0181	Schlauch Steering hose Durite	ACTROS
 			
21909			
 4 057822 219093	942 466 0281	Schlauch Steering hose Durite	ACTROS
 			











**KTK No.**















19870















**RF No.****Bezeichnung  
Description  
Désignation****Erläuterungen  
Remarks  
Remarques**















000 466 4502















Ölbehälter, mit Filter  
Steering Oil tank  
Réservoir d'huile, avec filtre

KTK No.	RF No.	Bezeichnung Description Désignation	Erläuterungen Remarks Remarques
08885	 4 057822 088859	  346 460 0105 346 460 0005	Lenkstange Drag link Barre de direction  L series 1924 L = 770mm Front axle
08887	 4 057822 088873	  001 460 2248 000 460 2848 000 460 0348 000 460 0948 000 460 8948	Kugelgelenk Tie rod end R/H Rotule  M24x1.5 M30x1.5 L = 120mm L series ACTROS SK/MK/NG
08888	 4 057822 088880	  001 460 2348 000 460 3448	Kugelgelenk Tie rod end L/H Rotule  A = M24x1.5 B = M30x1.5 L = 120mm
08886	 4 057822 088866	  346 460 1505 343 460 1505 343 460 1405	Lenkstange Drag link Barre de direction  L = 760mm Front axle MK-2422/2522/ 2524/2527
08889	 4 057822 088897	  387 460 3305 387 460 3205 387 460 1405 647 460 0005 647 460 0105	Lenkstange Drag link Barre de direction  L = 865mm MK/NG

KTK No.	RF No.	Bezeichnung Description Désignation	Erläuterungen Remarks Remarques
08890			
  4 057822 088903   	620 460 3705 620 460 0005 620 460 2005 620 460 2805	Lenkstange Drag link Barre de direction	3325, 3535 L = 885mm MK/SK/NG
16253			
  4 057822 162535   	002 460 4405 002 460 4305	Lenkstange Drag Link Barre de direction	ACTROS 1831-4148 ATEGO 1823-1828 L = 834mm
16254			
  4 057822 162542   	002 460 4705 002 460 4805	Lenkstange Drag Link	ACTROS 1831-3357 ACTROS 1832-2658 AXOR 1823-3228 ATEGO 1823-2628 L = 863mm
18556			
  4 057822 185565   	002 460 6105 002 460 6205 003 460 4205	Lenkstange Drag Link Barre de direction	L = 863mm ACTROS
19187			
  4 057822 191870   	002 460 8905 002 460 8805	Lenkstange Drag Link Barre de direction	L = 681mm ACTROS/AXOR













KTK No.		RF No.	Bezeichnung Description Désignation	Erläuterungen Remarks Remarques
20301	 4 057822 203016			
		000 460 9805 000 460 9905	Lenkstange Drag Link Barre de direction	L = 900mm SK
21558	 4 057822 215583			
		972 460 1405 972 460 1605	Lenkstange Drag Link Barre de direction	Atego 1077/2 L = 837mm
21554	 4 057822 215545			
		002 460 9605 002 460 9705 003 460 5705	Lenkstange Drag Link Barre de direction	Actros MP2 / MP3 L = 858mm
21555	 4 057822 215552			
		002 460 2405 002 460 3005	Lenkstange Drag Link Barre de direction	L = 927mm Actros 2551
21556	 4 057822 215552			
		000 460 9305 001 460 6905	Lenkstange Drag Link Barre de direction	L = 873mm Actros 2031/41











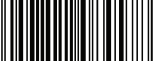



KTK No.	RF No.	Bezeichnung Description Désignation	Erläuterungen Remarks Remarques
21557			
 4 057822 215576			
  	000 460 9505 001 460 7105	Lenkstange Drag Link Barre de direction	L = 904mm Actros 4140/48
21559			
 4 057822 215590			
  	974 460 1005 974 460 1205	Lenkstange Drag Link Barre de direction	Atego 1214/18 L = 895mm
21560			
 4 057822 215606			
  	974 460 0405 974 460 0805 974 460 2205 976 460 0205	Lenkstange Drag Link Barre de direction	Atego 1518/23 L = 830mm
21561			
 4 057822 215613			
  	972 460 1005 972 460 1205	Lenkstange Drag Link Barre de direction	L = 873mm Atego 2. 918/25
21562			
 4 057822 215620			
  	001 460 5105 001 460 8105	Lenkstange Drag Link Barre de direction	L = 909mm Actros MP2/MP3















KTK No.		RF No.	Bezeichnung Description Désignation	Erläuterungen Remarks Remarques
21563	 4 057822 215637			
  		001 460 4905	Lenkstange Drag Link Barre de direction	L = 839mm Actros MP2/MP3 4410
21564	 4 057822 215644			
  		002 460 5105 002 460 5205	Lenkstange Drag Link Barre de direction	Actros L = 885mm
21565	 4 057822 215651			
  		002 460 4905 002 460 5005	Lenkstange Drag Link Barre de direction	Axor 2 L = 895mm
15403	 4 057822 154035			
  		001 460 0548 001 460 2548 000 460 5848	Kugelgelenk Tie rod end L/H Rotule	120x32 ACTROS 1831-4148 ACTROS 1832-2658 ATEGO 1823-2628 AXOR 1823-3228 MK 1417-2534 NG 1422-3850 SK 1831-4850
15404	 4 057822 154042			
  		001 460 1748 001 460 7648	Kugelgelenk Tie rod end R/H Rotule	120x32





















KTK No.	RF No.	Bezeichnung Description Désignation	Erläuterungen Remarks Remarques
13366	 4 057822 133665		
		000 460 1748	Kugelgelenk Tie rod end R/H Rotule
135x38 ACTROS 1831-4148 ATEGO 1823-1828 NG 1928-3850 SK 1831-4850			
13365	 4 057822 133658		
		001 460 7948	Kugelgelenk Tie rod end LH Rotule
135X38			















KTK No.	RF No.	Bezeichnung Description Désignation	Erläuterungen Remarks Remarques
07753			
			
		302 490 0080	Dichtung Gasket Joint  75.5 mm Steel Plated
06485			
			
		302 490 0080 CPL	Reparatursatz Repair Kit Kit de réparatio  75.5mm L series SK/MK/NG
06484			
			
		350 492 0080 CPL	Dichtung Repair Kit Turbo Joint  91.5mm L series
07754			
			
		350 492 0080	Dichtung Gasket Kit de réparatio  91.5 mm Steel Plated



KTK No.	RF No.	Bezeichnung Description Désignation	Erläuterungen Remarks Remarques
08457	 4 057822 084578		
		620 490 0365 Flexibles Rohr Flexible pipe Tube flexible	D x L = 90 x 285 SK/MK/NG
11398	 4 057822 113988		
		620 997 0490 Schelle Clamp Bride	3" pipe
17234	 4 057822 172343		
		617 492 0008 Muffe Connector Manchon	3" SK/MK/NG 356/366/402/ 441/442
08458	 4 057822 084585		
		620 490 0465 Flexibles Rohr Flexible pipe Tube flexible	105 x 285 SK/MK/NG
11399	 4 057822 113995		
		620 997 0590 Schelle Clamp Bride	3.5"

KTK No.		RF No.	Bezeichnung Description Désignation	Erläuterungen Remarks Remarques
17233	 4 057822 172336			
		620 492 0208	Muffe Connector Manchon	3.5"
				
08456	 4 057822 084561			
		621 490 0065	Stahlmessband Flexible pipe Pipe flexible	115 x 290 SK/MK/NG
				
11400	 4 057822 114008			
		621 997 0090	Schelle Clamp Bride	4"
				
17232	 4 057822 172329			
		621 492 0008	Muffe Connector Manchon	4"
				
17230	 4 057822 172305			
		973 490 0165	Flexibles Rohr Flexible hose Tube flexible	90mm ATEGO/ATEGO 2 1620/1622/1625 2423/2428
				













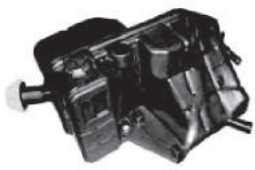

KTK No.	RF No.	Bezeichnung Description Désignation	Erläuterungen Remarks Remarques
17231			
 4 057822 172312	970 490 0265	Flexibles Rohr Flexible hose Tube flexible	75mm ATEGO/ATEGO 2 1215/1218/1318 1418/1718
			
12445			
 4 057822 124458		Flexibles Rohr Flexible hose Tube flexible	110mm 10 Mtr. per roll
			
12446			
 4 057822 124465		Flexibles Rohr Flexible hose Tube flexible	120mm 10 Mtr. per roll
			

KTK No.	RF No.	Bezeichnung Description Désignation	Erläuterungen Remarks Remarques	
18515	 4 057822 185152			
		942 490 2219 942 490 4019	Auspuffrohr Exhaust Pipe Tuyau d'échappement	Actros Front
18516	 4 057822 185169			
		942 490 3119 942 490 2319 942 490 4219	Auspuffrohr Exhaust Pipe Tuyau d'échappement	Actros Front
18517	 4 057822 185176			
		942 490 3019 942 490 4119	Auspuffrohr Exhaust Pipe Tuyau d'échappement	Actros









KTK No.	RF No.	Bezeichnung Description Désignation	Erläuterungen Remarks Remarques	
07759	 4 057822 077594			
		338 500 0045	Buchse Bush Bague	L series
07763	 4 057822 077631			
		338 500 0045 CPL	Reparatursatz Repair kit Kit de réparation	
07756	 4 057822 077563			
		336 504 0012	Gummilager Mounting Silentbloc	L series 10 mm
07755	 4 057822 077556			
		347 504 0012	Gummilager Mounting Silentbloc	NG/SK/L series 10 mm
07757	 4 057822 077570			
		387 504 0012	Gummilager Rubber mounting Silentbloc	SK/MK/NG

KTK No.	RF No.	Bezeichnung Description Désignation	Erläuterungen Remarks Remarques
07758	 4 057822 077587	 620 504 0112 Gummilager Mounting Silentbloc	SK/MK/NG New version
11172	 4 057822 111724	 942 504 0214 Gummilager Mounting Silentbloc	ACTROS



KTK No.		RF No.	Bezeichnung Description Désignation	Erläuterungen Remarks Remarques
17201	 4 057822 172015			
		000 500 3149	Ausdehnungsgefäß Expansion tank Vase d'expansion	ACTROS 930/934 950/954/957
17202	 4 057822 172022			
		000 500 3049	Ausdehnungsgefäß Expansion tank Vase d'expansion	ACTROS 930/932/933/934 950/952/953/954
20582	 4 057822 205829			
		000 500 2249	Ausdehnungsgefäß Expansion tank Vase d'expansion	ACTROS 3340
20942	 4 057822 209421			
		000 500 2149	Ausdehnungsgefäß Expansion tank Vase d'expansion	
22095	 4 057822 220952			
		940 501 0003	Ausdehnungsgefäß Expansion tank Vase d'expansion	Actros/Atego

KTK No.	RF No.	Bezeichnung Description Désignation	Erläuterungen Remarks Remarques
22098			
	 <p>4 057822 220983</p> 	<p>357 500 0249 357 500 1049</p> <p>Ausdehnungsgefäß Expansion tank Vase d'expansion</p>	<p>500/300</p>

KTK No.	RF No.	Bezeichnung Description Désignation	Erläuterungen Remarks Remarques
11779			
 4 057822 117795			
	000 501 6415	Kühlerverschluss Radiator cap Bouchon de radiateur	ACTROS SK/MK/NG
			
12796			
 4 057822 127961			
	000 501 4215	Kühlerverschluss Radiator cap Bouchon de radiateur	L series SK/MK/NG
			
12797			
 4 057822 127978			
	000 501 4615 000 501 7215	Kühlerverschluss Radiator cap Bouchon de radiateur	L series SK/MK/NG
			

KTK No.		RF No.	Bezeichnung Description Désignation	Erläuterungen Remarks Remarques
10654	 4 057822 106546	346 501 5182	Kühlerschlauch Radiator hose Durite de radiateur	L series
10262	 4 057822 102623	387 501 2982	Kühlerschlauch Radiator hose Durite de radiateur	SK/MK/NG
10652	 4 057822 106522	941 501 0382	Kühlerverschluss Radiator hose Bouchon de radiateur	ACTROS/AXOR
10653	 4 057822 106539	620 501 3782	Kühlerverschluss Radiator hose Bouchon de radiateur	ACTROS/AXOR
21914	 4 057822 219147	942 501 1682	Kühlerverschluss Radiator hose Bouchon de radiateur	ACTROS

KTK No.	RF No.	Bezeichnung Description Désignation	Erläuterungen Remarks Remarques
21915			
 4 057822 219154  	942 501 0682	Kühlerschlauch Radiator hose Durite de radiateur	ACTROS
21916			
 4 057822 219161  	942 506 3235	Kühlerschlauch Radiator hose Durite de radiateur	ACTROS
21901			
 4 057822 219017  	617 501 4982	Kühlerverschluss Radiator hose Bouchon de radiateur	422
21902			
 4 057822 219024  	655 501 1082	Kühlerverschluss Radiator hose Bouchon de radiateur	422
21903			
 4 057822 219031  	620 501 1082	Kühlerverschluss Radiator hose Bouchon de radiateur	422

KTK No.	RF No.	Bezeichnung Description Désignation	Erläuterungen Remarks Remarques
21904	 4 057822 219048		
 	617 501 0082	Kühlerschlauch Radiator hose Durite de radiateur	LP
21905	 4 057822 219055		
 	620 501 2982	Kühlerschlauch Radiator hose Durite de radiateur	LP
21906	 4 057822 219062		
 	655 501 1282	Kühlerverschluss Radiator hose Bouchon de radiateur	LP
21907	 4 057822 219079		
 	941 501 0282	Kühlerverschluss Radiator hose Bouchon de radiateur	ACTROS
21910	 4 057822 219107		
 	942 506 1635	Kühlerverschluss Radiator hose Bouchon de radiateur	ACTROS

KTK No.		RF No.	Bezeichnung Description Désignation	Erläuterungen Remarks Remarques
21911	 4 057822 219116			
		942 506 4135	Kühlerschlauch Radiator hose Durite de radiateur	ACTROS
21912	 4 057822 096731			
		942 501 1582	Kühlerschlauch Radiator hose Durite de radiateur	ACTROS
21940	 4 057822 219406			
		941 501 1282	Kühlerschlauch Radiator hose Durite de radiateur	
21941	 4 057822 219413			
		942 501 0582	Kühlerschlauch Radiator hose Durite de radiateur	
21942	 4 057822 219420			
		900 271 050 005	Kühlerschlauch Radiator hose Durite de radiateur	

KTK No.	RF No.	Bezeichnung Description Désignation	Erläuterungen Remarks Remarques
10349			
 <p>4 057822 103491</p>			
	656 505 0286	Gummiring, für Lüfter Fan rubber Anneau de caoutchouc, pour ventilateur	SK/MK/NG
10350			
 <p>4 057822 103507</p>			
	620 505 0086	Gummiring, für Lüfter Fan rubber Anneau de caoutchouc, pour ventilateur	SK/MK/NG



KTK No.	RF No.	Bezeichnung Description Désignation	Erläuterungen Remarks Remarques
21913	 4 057822 219130		
		942 528 1282 Kühlerschlauch 942 528 0582 Hose, oil filler connector Schlauch, Öleinfüllstutzen	ACTROS

KTK No.	RF No.	Bezeichnung Description Désignation	Erläuterungen Remarks Remarques
10857			
 4 057822 108571			
 	003 545 8324	Lenkstockschalter Steering column switch Commodo	L series
10858			
 4 057822 108588			
 	005 545 5124 005 545 3824	Lenkstockschalter Steering column switch Commodo	SK/MK/NG
10852			
 4 057822 108526			
 	620 540 0045	Lenkstockschalter Steering column switch Commodo	SK/MK/NG
10853			
 4 057822 108533			
 	620 540 0145	Lenkstockschalter Steering column switch Commodo	SK/MK/NG
13866			
 4 057822 138660			
 	008 545 0124	Lenkstockschalter Steering column switch Commodo	ACTROS/AXOR

**KTK No.**

10854



**RF No.**

655 540 0045











**Bezeichnung  
Description  
Désignation**

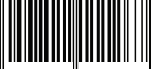



















Lenkstockscharter  
Steering column switch  
Commodo

















**Erläuterungen  
Remarks  
Remarques**

SK/MK/NG



KTK No.	RF No.	Bezeichnung Description Désignation	Erläuterungen Remarks Remarques
11125	 4 057822 111250	  004 542 5617	Temperatursensor Temperature sensor Sonde de température  L series SK/MK/NG
11126	 4 057822 111267	  002 542 1717	Öldruckgeber Oil pressure sensor Capteur de pression d'huile  L series SK/MK/NG
11127	 4 057822 111274	  004 542 4317 001 542 8217 684 542 7117	Öldruckgeber Oil pressure sensor Capteur de pression d'huile  SK/MK/NG L series M18x1.5
11128	 4 057822 111281	  004 542 8917 684 542 7317 001 542 4917	Öldruckgeber Oil pressure sensor Capteur de pression d'huile  L series SK/MK/NG M14x1.5
19756	 4 057822 197568	  002 542 3118	ABS Sensor  0.4 Mtr

KTK No.	RF No.	Bezeichnung Description Désignation	Erläuterungen Remarks Remarques
19815			
 4 057822 198152			
  	009 542 1017	Impulsgeber Impulse sensor (RPM) Capteur d'impulsions	Actros/Axor/Atego 4 Pin
19816			
 4 057822 198169			
  	005 542 9417 006 542 4617	Impulsgeber Impulse sensor (RPM) Capteur d'impulsions	3 Pin
19817			
 4 057822 198176			
  	013 542 6217 015 542 2417	Impulsgeber Impulse sensor (RPM) Capteur d'impulsions	Actros/Axor 4 Pin
19818			
 4 057822 198183			
  	012 542 5617	Impulsgeber Impulse sensor Capteur d'impulsions	
19821			
 4 057822 198213			
  	001 542 3318 001 542 3518 001 542 8418 001 542 8818 002 542 2618	ABS Sensor, links ABS sensor, left Capteur ABS, gauche	Actros/Axor/Atego 3 MTR

KTK No.	RF No.	Bezeichnung Description Désignation	Erläuterungen Remarks Remarques
19823			
  	 4 057822 198237  942 542 0217 942 542 0017	Niveaugeber, Kühlmittel Coolant level sensor Capteur de niveau, liquide de refroidissement	Actros/Atego/Axor
19824			
  	 4 057822 198244  000 542 9118	Positionssensor Position sensor Capteur de position	Actros/Axor
19828			
 	 4 057822 198282  655 542 0017	Niveaugeber, Kühlmittel Coolant level sensor Capteur de niveau, liquide de refroidissement	
22110			
 	 4 057822 221102  001 542 9218 001 542 6518 000 430 3907	Drucksensor Pressure sensor Capteur de pression	ACTROS
22113			
 	 4 057822 221133  004 542 4618 004 542 4618	ABS sensor	ACTROS 3600mm

**KTK No.**















20688

**RF No.****Bezeichnung  
Description  
Désignation****Erläuterungen  
Remarks  
Remarques**010 542 7818  
010 542 7817

Distance sensor















0 500/300

















KTK No.	RF No.	Bezeichnung Description Désignation	Erläuterungen Remarks Remarques
11129			
 4 057822 111298			
  	001 542 8716	Tachometer	L series
11130			
 4 057822 111304			
  	001 542 4503 002 542 4503	Tankanzeige Fuel level gauge Jauge à carburant	L series SK/MK/NG
11131			
 4 057822 111311			
  	003 542 3305	Temperaturanzeige Temperature gauge Sonde de température	L series
11132			
 4 057822 111328			
  	001 542 9902	Oil pressure gauge Ölmanometer Manomètre huile	L series
11133			
 4 057822 111335			
  	001 542 4202	Ölmanometer Oil pressure gauge Manomètre huile	L series



KTK No.	RF No.	Bezeichnung Description Désignation	Erläuterungen Remarks Remarques
11134			
 4 057822 111342			
	000 542 8703	Tankanzeige Fuel gauge Jauge à carburant	L series 336/338 343/346/349
			

KTK No.	RF No.	Bezeichnung Description Désignation	Erläuterungen Remarks Remarques
08913	 4 057822 089139		
  	000 545 8114	Schalter Switch, speed limitation Interrupteur	G12/155/180 L series
08906	 4 057822 089061		
  	003 545 1614 001 545 3414	Schalter Switch, reverse light Interrupteur	L series SK/MK/NG
08916	 4 057822 089160		
  	000 545 4909	Bremslichtschalter Switch, Brake light Interrupteur feu de freinage	L series
08905	 4 057822 089054		
  	000 545 6909	Schalter Switch, brake light Interrupteur	L series SK/MK/NG
08908	 4 057822 089085		
  	000 545 7009	Schalter Switch, brake light Interrupteur	L series

KTK No.	RF No.	Bezeichnung Description Désignation	Erläuterungen Remarks Remarques
08907	 4 057822 089078		
  	000 545 7909 000 545 9009	Schalter Switch, brake light Interrupteur	L series SK/MK/NG
08915	 4 057822 089153		
  	001 545 1209 000 545 9109	Schalter Switch, reverse lamp Interrupteur	G125,135 155,180 SK/MK/NG
08914	 4 057822 089146		
  	001 545 1309 000 545 9409	Schalter Switch, reverse lamp Interrupteur	G125,135 155,180 SK/MK/NG
19825	 4 057822 198251		
  	001 545 7309 001 545 1609	Schalter, Anlass-Sperre Switch, starting lock Interrupteur verrouillage de démarrage	Actros/Atego/Axor
19826	 4 057822 198268		
  	001 545 4909 001 545 1809	Schalter Switch, rear brake light Interrupteur	Actros/Axor/Atego

**KTK No.**

19827





4 057822 198275

**RF No.**

001 545 1709

**Bezeichnung  
Description  
Désignation**Schalter, Anlass-Sperre  
Switch, starting lock  
Interrupteur, verrouillage de démarrage**Erläuterungen  
Remarks  
Remarques**

KTK No.	RF No.	Bezeichnung Description Désignation	Erläuterungen Remarks Remarques
10860	 4 057822 108601	 	001 544 7432 Warnblinkrelais 11 port 002 544 2832 Hazard relay 24V 002 544 1432 Relais de signal de détresse SK/MK/NG
19864	 4 057822 198640	 	003 544 5032 Blinkrelais 18 Pin Turn signal relay Relais de clignotant

KTK No.	RF No.	Bezeichnung Description Désignation	Erläuterungen Remarks Remarques
10975			
	 4 057822 109752  	387 540 0139 887 540 0139  Elektrische Spule Electric coil Bobine électrique	7pin 24V
10973			
	 4 057822 109738  	001 545 0626 006 545 0625  Socket	7 pin
10974			
	 4 057822 109745  	004 545 2128  Plug	7pin
17589			
	 4 057822 175894  	000 540 3839 000 540 6239  Elektrische Spule Electric coil Bobine électrique	7 pin
13322			
	 4 057822 133221  	000 540 6339  Elektrische Spule Electric coil Bobine électrique	15 Pole - 24V 3.5 mtr. ID: φ44

**KTK No.**

13323



**RF No.**

**Bezeichnung  
Description  
Désignation**









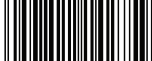

**Erläuterungen  
Remarks  
Remarques**

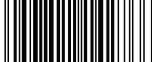

000 545 4084









Elektrische Spule  
Electric coil  
Bobine électrique





15 Pole  
7 pole - 2 plugs  
3.5mtr.  
ID: φ40















KTK No.	RF No.	Bezeichnung Description Désignation	Erläuterungen Remarks Remarques
14275	 4 057822 142759		
		001 553 3505 Kippzylinder 001 553 1605 Cabin cylinder Vérin basculement de cabine	L = 632 SK/MK/NG
14276	 4 057822 142766		
		001 553 4205 Kippzylinder 000 553 5105 Cabin cylinder 000 553 7205 Vérin basculement de cabine	L = 673 SK/MK/NG 380/381/382/385 387/393/397
21578	 4 057822 215781		
		001 553 3605 Kippzylinder 000 553 2805 Cabin cylinder 000 553 4405 Vérin basculement de cabine	
14277	 4 057822 142773		
		000 553 7901 Hydraulikpumpe 371 553 7001 Cabin pump 000 553 6801 Pompe de levage de cabine 000 553 7901	SK/MK/NG















KTK No.	RF No.	Bezeichnung Description Désignation	Erläuterungen Remarks Remarques
16720	 4 057822 167202		
		001 553 3601	Hydraulikpumpe Cabin pump Pompe de levage de cabine LH ACTROS
16721	 4 057822 167219		
		001 553 3701	Hydraulikpumpe Cabin pump RH Pompe de levage de cabine ACTROS















KTK No.	RF No.	Bezeichnung Description Désignation	Erläuterungen Remarks Remarques
08459	 4 057822 084592		
		309 673 0031	Dichtleiste, Türfenster Sealing strip, door window Kit de joints, vitre de portière 3.05mtr Per Roll L series SK/MK/NG
08460	 4 057822 084608		
		673 697 0098	Dichtleiste Sealing strip Kit de joints 4330mm Per roll L series SK/MK/NG
08469	 4 057822 084691		
		389 881 0298	Dichtleiste Sealing strip Kit de joints 1900mm Per roll L series SK/MK/NG















KTK No.		RF No.	Bezeichnung Description Désignation	Erläuterungen Remarks Remarques
08790	 4 057822 087906	322 725 0202	Fensterheber Window regulator Lève-vitr	L series LH
08791	 4 057822 087913	322 725 0302	Fensterheber Window regulator Lève-vitr	RH
08788	 4 057822 087883	381 725 0002	Fensterheber Glass winder Lève-vitr	SK/MK/NG LH
08789	 4 057822 087895	381 725 0102	Fensterheber Glass winder Lève-vitr	RH
11773	 4 057822 117733	941 720 0446	Fensterheber Window regulator Lève-vitr	ACTROS/AXOR LH

KTK No.		RF No.	Bezeichnung Description Désignation	Erläuterungen Remarks Remarques		
19991	 4 057822 199913	941 720 0546	Fensterheber Window regulator Lève-vitr	ACTROS/AXOR RH		
		19992	 4 057822 199920	000 725 0002	Fensterheber Window regulator Lève-vitr	Automatic LH
		19993	 4 057822 199937	000 725 0102	Fensterheber Glass winder Lève-vitr	Automatic RH
		21798	 4 057822 217983	973 720 0346	Fensterheber Window regulator Lève-vitr	With Motor LH
		21799	 4 057822 217990	973 720 0446	Fensterheber Window regulator Lève-vitr	With Motor RH
						















KTK No.	RF No.	Bezeichnung Description Désignation	Erläuterungen Remarks Remarques
08786			
 4 057822 087869			
	641 720 0246	Fensterheber Window regulator Lève-vitr	SK/MK/NG LH
			
08787			
 4 057822 087876			
	641 720 0346	Fensterheber Window regulator Lève-vitr	RH
			















KTK No.		RF No.	Bezeichnung Description Désignation	Erläuterungen Remarks Remarques
11775	 4 057822 117757			
		381 725 0060	Fensterkurbel Handle, regulator Poignée	SK/MK/NG
11780	 4 057822 117801			
		673 760 0002	Fensterkurbel Handle, regulator Poignée	SK/MK/NG
12985	 4 057822 129859			
		641 720 0095	Armlehne Arm rest Accoudoir	SK/MK/NG LH
12986	 4 057822 129866			
		641 720 0195	Armlehne Arm rest Accoudoir	SK/MK/NG RH















KTK No.		RF No.	Bezeichnung Description Désignation	Erläuterungen Remarks Remarques
09945	 4 057822 099459			
		641 760 0259	Türgriff Door handle Poignée de portière	SK/MK/NG LH
09946	 4 057822 099466			
		641 760 0359	Türgriff Door handle Poignée de portière	RH
11781	 4 057822 117818			
		381 766 0901 381 760 0159 670 760 0159	Türgriff Door handle Poignée de portière Left & Right	L series SK/MK/NG
11777	 4 057822 117771			
		941 760 0459	Türgriff Door handle LH Poignée de portière	ACTROS/AXOR
11778	 4 057822 117788			
		941 760 0559	Türgriff Door handle RH	ACTROS/AXOR Poignée de portière









KTK No.	RF No.	Bezeichnung Description Désignation	Erläuterungen Remarks Remarques
<p>10655</p>  <p>4 057822 106553</p>  	<p>641 760 0004</p>	<p>Zugkabel Door lock cable Câble</p>	<p>SK/MK/NG</p>
<p>11771</p>  <p>4 057822 117719</p>  	<p>381 723 0201 381 723 0001</p>	<p>Schloss Door lock Serrure</p>	<p>SK/MK/NG LH</p>
<p>11772</p>  <p>4 057822 117726</p>  	<p>381 723 0301 381 723 0101</p>	<p>Schloss Door lock Serrure</p>	<p>SK/MK/NG RH</p>
<p>23347</p>  <p>4 057822 233471</p>  	<p>973 720 0735</p>	<p>Schloss Door lock Serrure</p>	<p>LH MP2</p>
<p>23348</p>  <p>4 057822 233488</p>  	<p>973 720 0835</p>	<p>Schloss Door lock Serrure</p>	<p>RH MP2</p>













KTK No.	RF No.	Bezeichnung Description Désignation	Erläuterungen Remarks Remarques
17778			
  	941 820 5461 941 820 2861	Hauptscheinwerfer Head light RH Phare principal	ACTROS/ATEGO H4 Without fog lamp
17779			
  	941 820 5361 941 820 2761	Hauptscheinwerfer Head light LH Phare principal	ACTROS/ATEGO H4 Without fog lamp
17780			
  	941 820 5161 941 820 2561	Hauptscheinwerfer Head light LH Phare principal	ACTROS/ATEGO H4/H1 With fog lamp
17781			
  	941 820 5261 941 820 2661	Hauptscheinwerfer Head light RH Phare principal	ACTROS/ATEGO H4/H1 With fog lamp
17782			
  	941 820 5561 941 820 2961	Hauptscheinwerfer Head light LH Phare principal	ACTROS/ATEGO H4 Head light levelling (Electric)



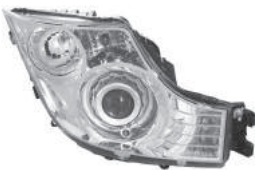







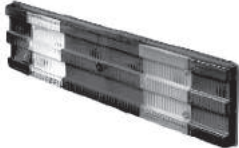



KTK No.		RF No.	Bezeichnung Description Désignation	Erläuterungen Remarks Remarques
17783	 4 057822 177836			
		941 820 5661 941 820 3061	Hauptscheinwerfer Head light RH Phare principal	ACTROS/ATEGO H4 Head light levelling (Electric)
17788	 4 057822 177881			
		943 820 0161	Hauptscheinwerfer Head light Phare principal	ACTROS LH H7/H1
17789	 4 057822 177898			
		943 820 0261	Hauptscheinwerfer Head light RH Phare principal	ACTROS H7/H1
17790	 4 057822 177904			
		943 820 0461	Hauptscheinwerfer Head light RH Phare principal	ACTROS Headlight levelling (Electric)
17791	 4 057822 177911			
		943 820 0361	Hauptscheinwerfer Head light LH Phare principal	ACTROS Headlight levelling (Electric)







KTK No.		RF No.	Bezeichnung Description Désignation	Erläuterungen Remarks Remarques
19134	 4 057822 191344			
		943 820 1561	Hauptscheinwerfer Head light RH Phare principal	Actros
19135	 4 057822 191351			
		943 820 1461	Hauptscheinwerfer Head light LH Phare principal	Actros
19136	 4 057822 191368			
		943 820 1761	Hauptscheinwerfer Head light RH Phare principal	Actros (With motor)
19137	 4 057822 191375			
		943 820 1661	Hauptscheinwerfer Head light LH Phare principal	Actros (With motor)
19130	 4 057822 191306			
		943 820 0156	Nebelscheinwerfer Fog lamp RH Phare anti-brouillard	Actros

KTK No.		RF No.	Bezeichnung Description Désignation	Erläuterungen Remarks Remarques
19131	 4 057822 191313			
		943 820 0056	Nebelscheinwerfer Fog lamp LH Phare anti-brouillard	Actros
19132	 4 057822 191320			
		940 820 0261	Hauptscheinwerfer Head light RH Phare principal	Axor
19133	 4 057822 191337			
		940 820 0161	Hauptscheinwerfer Head light LH Phare principal	Axor
19138	 4 057822 191382			
		973 820 2761 973 820 2961	Hauptscheinwerfer Head light RH Phare principal	Atego
19139	 4 057822 191399			
		973 820 2661 973 820 2861	Hauptscheinwerfer Head light LH Phare principal	Atego











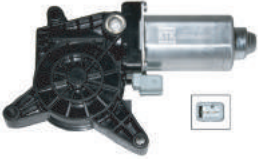

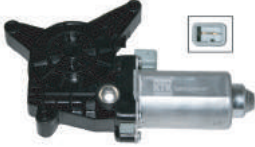
KTK No.		RF No.	Bezeichnung Description Désignation	Erläuterungen Remarks Remarques
23497	 4 057822 234973	960 820 0539	  Hauptscheinwerfer Head light Phare principal	ACTROS MP4
23498	 4 057822 234980	960 820 0439	  Hauptscheinwerfer Head light Phare principal	ACTROS MP4
23499	 4 057822 234997	960 820 0939	  Hauptscheinwerfer Head light Phare principal	ACTROS MP4 XENON Type
23500	 4 057822 235000	960 820 0839	  Hauptscheinwerfer Head light Phare principal	ACTROS MP4 XENON Type

KTK No.		RF No.	Bezeichnung Description Désignation	Erläuterungen Remarks Remarques
17784	 4 057822 177843			
		001 540 5870 001 540 6370	Rückleuchte Rear light RH Feu arrière	ACTROS/AXOR
17785	 4 057822 177850			
		001 540 5770 001 540 6270	Rückleuchte Rear light LH Feu arrière	ACTROS/AXOR
17786	 4 057822 177867			
		002 544 1290 002 544 3690	Lichtscheibe Lens, rear light LH Cabochon	ACTROS SK
20004	 4 057822 200046			
		000 826 2156 000 826 2356	Lichtscheibe Lens, rear light RH Cabochon	
20005	 4 057822 200053			
		000 826 2056 000 826 2256	Lichtscheibe Lens, rear light LH Cabochon	

KTK No.		RF No.	Bezeichnung Description Désignation	Erläuterungen Remarks Remarques
21536	 4 057822 215361			
		002 544 1690	Lichtscheibe Lens, rear light RH Cabochon	
20561	 4 057822 205614			
			Rotating Light	12V
20562	 4 057822 205621			
			Rotating Light	24V
23138	 4 057822 231385			
		003 544 1703	Rückleuchte Rear light LH Feu arrière	MP4
23140	 4 057822 231402			
		002 544 7390	Lichtscheibe Lens, rear light Cabochon	MP4

KTK No.	RF No.	Bezeichnung Description Désignation	Erläuterungen Remarks Remarques
23139			
 4 057822 231392			
 	003 544 1803	Rückleuchte Rear light RH Feu arrière	MP4 With buzzer
23137			
 4 057822 231378			
 	003 544 1603	Rückleuchte Rear light RH Feu arrière	MP4



KTK No.	RF No.	Bezeichnung Description Désignation	Erläuterungen Remarks Remarques
21804			
 4 057822 218041			
 	000 820 4908 000 820 2808	Fensterhebermotor Window lift motor, electric LH Moteur de lève-vitre	Actros / Axor 943
21805			
 4 057822 218058			
 	000 820 5008 000 820 2908	Fensterhebermotor Window lift motor, electric RH Moteur de lève-vitre	Actros / Axor 943
21806			
 4 057822 218065			
 	000 820 5108 000 820 2608	Fensterhebermotor Window lift motor, electric LH Moteur de lève-vitre	Actros / Axor
21807			
 4 057822 218072			
 	000 820 5208 000 820 2708	Fensterhebermotor Window lift motor, electric RH Moteur de lève-vitre	Actros / Axor
21800			
 4 057822 218003			
 	005 820 9142 000 820 2708	Fensterhebermotor Window lift motor, electric RH Moteur de lève-vitre	Actros / Axor

**KTK No.**

21801



**RF No.**

005 820 9042

**Bezeichnung  
Description  
Désignation**







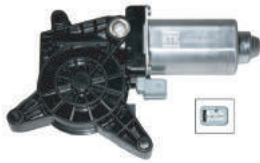



Fensterhebermotor  
Window lift motor, electric LH  
Moteur de lève-vitre

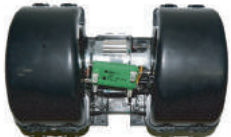

**Erläuterungen  
Remarks  
Remarques**

Actros / Axor











KTK No.	RF No.	Bezeichnung Description Désignation	Erläuterungen Remarks Remarques
21797			
 4 057822 217976			
  	003 820 5042 001 820 1501	Wiper motor	402 / 403 / 422

KTK No.	RF No.	Bezeichnung Description Désignation	Erläuterungen Remarks Remarques
22015			
 4 057822 220150			
  	001 830 0208	Gebläsemotor Fan motor Moteur de ventilateur	
22017			
 4 057822 220174			
  	003 830 0508	Gebläsemotor Fan motor Moteur de ventilateur	Actros MP2/MP3
22018			
 4 057822 220181			
  	001 830 8708	Gebläsemotor Fan motor Moteur de ventilateur	Actros
22019			
 4 057822 220198			
  	002 830 8408	Gebläsemotor Fan motor Moteur de ventilateur	Actros MP2/MP3















KTK No.	RF No.	Bezeichnung Description Désignation	Erläuterungen Remarks Remarques
11114			
	000 860 3226	Wischwasserpumpe Washer pump Pompe de lave glace	L series SK/MK/NG
11115			
	000 869 3121	Wischwasserpumpe Washer pump Pompe de lave glace	SK/MK/NG















KTK No.	RF No.	Bezeichnung Description Désignation	Erläuterungen Remarks Remarques
23091			
			
 	942 890 0519	Kabinenstoßdämpfer Shock absorber Amortisseur de cabine	
22761			
			
 	943 890 4919	Kabinenstoßdämpfer Shock absorber Amortisseur de cabine	
22760			
			
 	940 890 4619	Kabinenstoßdämpfer Shock absorber Amortisseur de cabine	
22639			
			
 	942 890 5419	Kabinenstoßdämpfer Shock absorber Amortisseur de cabine	
22947			
			
 	940 890 3919	Kabinenstoßdämpfer Shock absorber Amortisseur de cabine	







KTK No.	RF No.	Bezeichnung Description Désignation	Erläuterungen Remarks Remarques
22638	 4 057822 226381		
		942 890 4719	Kabinenstoßdämpfer Shock absorber Amortisseur de cabine
22640	 4 057822 226404		
		942 890 3119	Kabinenstoßdämpfer Shock absorber Amortisseur de cabine
22642	 4 057822 226428		
		000 891 2205	Kabinenstoßdämpfer Shock absorber Amortisseur de cabine
22759	 4 057822 227593		
		006 326 6700	Kabinenstoßdämpfer Shock absorber Amortisseur de cabine
22738	 4 057822 227388		
		942 890 5319	Kabinenstoßdämpfer Shock absorber Amortisseur de cabine

KTK No.	RF No.	Bezeichnung Description Désignation	Erläuterungen Remarks Remarques
22794	 4 057822 227944		
		942 890 2919	Kabinenstoßdämpfer Shock absorber Amortisseur de cabine
22641	 4 057822 226411		
		942 890 2919	Kabinenstoßdämpfer Shock absorber Amortisseur de cabine
22758	 4 057822 227586		
		942 890 0219	Kabinenstoßdämpfer Shock absorber Amortisseur de cabine



KTK No.	RF No.	Bezeichnung Description Désignation	Erläuterungen Remarks Remarques
07410			
 4 057822 074104			
  	001 997 0772	Adaptor	14x18mm
10870			
 4 057822 108700			
  	001 990 7368	Adaptor	22 x 16mm
21785			
 4 057822 217853			
  	030 997 1748 673 997 0045	Repair kit, compressor	
21786			
 4 057822 217860			
  	673 997 0145	Repair kit	
21787			
 4 057822 217877			
  	000 997 0834 000 997 3734	Union nut	9.5mm

KTK No.	RF No.	Bezeichnung Description Désignation	Erläuterungen Remarks Remarques
21788	 4 057822 217884		
		000 997 0934	Union Nut
08273	 4 057822 082734		
		915 011 008 103	Banjo Bolt 14mm
08274	 4 057822 082741		
		915 011 010 102	Banjo Bolt
08275	 4 057822 082758		
		915 047 010 100	Banjo Bolt
08276	 4 057822 082765		
		915 047 012 100	Banjo Bolt 16mm

KTK No.	RF No.	Bezeichnung Description Désignation	Erläuterungen Remarks Remarques
16558	 4 057822 165581	  915 047 008 100    Banjo Bolt 12mm	Double
16559	 4 057822 165598	  Fitting	22x18mm
16560	 4 057822 165604	  003 910 010 000    Fitting	16x1.5



KTK GERMANY GmbH

→ GR 99 02/01

KTK No.

12092



4 057822 120924

RF No.

Bezeichnung  
Description  
Désignation

Erläuterungen  
Remarks  
Remarques



























074 310 013 002















Brake hose 13x6mm







25 mtr. per Roll  
Actros/Atego

















KTK No.	RF No.	Bezeichnung Description Désignation	Erläuterungen Remarks Remarques
08861	 4 057822 088613		
		Luftspirale Air hose - Red Spirale pneumatique	M16x1.5
08862	 4 057822 088620		
		Luftspirale Air hose - Yellow Spirale pneumatique	M16x1.5
08863	 4 057822 088637		
		Luftspirale Air hose - Red Spirale pneumatique	M22x1.5
08864	 4 057822 088644		
		Luftspirale Air hose - Yellow Spirale pneumatique	M22x1.5
08865	 4 057822 088651		
		Luftspirale Air hose - Red Spirale pneumatique	R 1/2"









KTK No.	RF No.	Bezeichnung Description Désignation	Erläuterungen Remarks Remarques
08866	 4 057822 088668	  Luftspirale Air hose - Yellow Spirale pneumatique	R 1/2"
08869	 4 057822 088698	  000 429 3930 Kupplungskopf 000 429 5530 Palm coupling Automatic - Red Actros/Axor Main d'accouplement	M16x1.5 Atego/SK/MK/NG
08870	 4 057822 088705	  000 429 4030 Kupplungskopf 000 429 5630 Palm coupling Automatic - Yellow Main d'accouplement	M16x1.5
08873	 4 057822 088736	  000 429 3530 Kupplungskopf Palm coupling Automatic - Red Main d'accouplement	M22x1.5
08874	 4 057822 088743	  000 429 3630 Kupplungskopf Palm coupling Automatic - Yellow Main d'accouplement	M22x1.5











KTK No.	RF No.	Bezeichnung Description Désignation	Erläuterungen Remarks Remarques
08867	 4 057822 088675	  000 429 7630 Kupplungskopf 000 429 7730 Air hose coupling Ordinary-Red Main d'accouplement	M16x1.5 ACTROS/AXOR
08868	 4 057822 088682	  000 429 3830 Kupplungskopf Air hose coupling Ordinary-Yellow Main d'accouplement	M16x1.5
08871	 4 057822 088712	  000 429 3430 Kupplungskopf Air hose coupling Ordinary-Red Main d'accouplement	M22x1.5
08872	 4 057822 088729	  000 429 3330 Kupplungskopf Air hose coupling Ordinary-Yellow Main d'accouplement	M22x1.5
06942	 4 057822 069421	  000 429 2184 Ersatzgummi, Kupplungskopf Air Hose Coupling Rubber Caoutchouc de rechange, tête d'embrayage	















KTK No.	RF No.	Bezeichnung Description Désignation	Erläuterungen Remarks Remarques
07539	 4 057822 075392	 Ersatzgummi, Kupplungskopf Air Hose Coupling Rubber Caoutchouc de rechange, tête d'embrayage	
13319	 4 057822 133191	 Kupplungskopf Palm coupling - Red Main d'accouplement	M16x1.5
13320	 4 057822 133207	 Kupplungskopf - Gelb Palm coupling - Yellow Main d'accouplement	M16x1.5



























KTK No.	RF No.	Bezeichnung Description Désignation	Erläuterungen Remarks Remarques	
08854	 4 057822 088545			
		335 997 2282	Polyamidrohr Nylon pipe Tube de nylon	4x1 mm 25 Mtr Roll
08855	 4 057822 088552			
		008 997 6082	Polyamidrohr Nylon pipe Tube de nylon	6x1 mm 25 Mtr Roll
08856	 4 057822 088569			
		008 997 9082	Polyamidrohr Nylon pipe Tube de nylon	8x1 mm 25 Mtr Roll
08857	 4 057822 088576			
		001 997 0652	Polyamidrohr Nylon pipe Tube de nylon	10x1.25 mm 25 Mtr Roll
08858	 4 057822 088583			
		008 997 5482	Polyamidrohr Nylon pipe Tube de nylon	11x1.50 mm 25 Mtr Roll















KTK No.	RF No.	Bezeichnung Description Désignation	Erläuterungen Remarks Remarques	
08859	 4 057822 088590			
		010 997 5982	Polyamidrohr Nylon pipe Tube de nyl	12x1.50 mmt 25 Mtr Roll 25 Mtr Rollon
08860	 4 057822 088606			
		010 997 4682	Polyamidrohr Nylon pipe Tube de nylon	15x1.50 mm 25 Mtr Roll
14250	 4 057822 142506			
		000 987 5127	Polyamidrohr Nylon pipe Tube de nylon	16x2 mm 25 Mtr Roll

KTK No.		RF No.	Bezeichnung Description Désignation	Erläuterungen Remarks Remarques
07781	 4 057822 077815		  003 997 9172 Reparatursatz Fitting sets for tube Kit de réparation	4 x 1mm
07782	 4 057822 077822		  003 997 9172 Reparatursatz Fitting sets for tube Kit de réparation	6 x 1mm
07783	 4 057822 077839		  003 997 8972 Reparatursatz Fitting sets for tube Kit de réparation	8 x 1mm
07784	 4 057822 077846		  Reparatursatz Fitting sets for tube Kit de réparation	10 x 1mm
07785	 4 057822 077853		  004 997 1772 Reparatursatz Fitting sets for tube Kit de réparation	12 x 1.5mm

KTK No.	RF No.	Bezeichnung Description Désignation	Erläuterungen Remarks Remarques
07786	 4 057822 077860	Reparatursatz Fitting sets for tube Kit de réparation	15 x 1.5mm
  			
07766	 4 057822 077662	003 870 006 105 Union nut	6mm M 12 x 1.5
  			
07767	 4 057822 077679	003 870 008 102 Union nut	8mm M 14 x 1.5
  			
07768	 4 057822 077686	003 870 010 103 Union nut	10mm M 16 x 1.5
  			
07769	 4 057822 077693	003 870 012 104 Union nut	12mm M 18 x 1.5
  			

KTK No.	RF No.	Bezeichnung Description Désignation	Erläuterungen Remarks Remarques
07770	 4 057822 077709	003 870 015 101 Union nut	15mm M 22 x 1.5
			
07771	 4 057822 077716	003 861 006 006 Outer sleeve	6mm
			
07772	 4 057822 077723	003 861 008 004 Outer sleeve	8mm
			
07773	 4 057822 077730	003 861 010 006 Outer sleeve	10mm
			
07774	 4 057822 077747	003 861 012 006 Outer sleeve	12mm
			

KTK No.	RF No.	Bezeichnung Description Désignation	Erläuterungen Remarks Remarques
07775	 4 057822 077754		
		003 861 015 004 Outer sleeve	15mm
07776	 4 057822 077761		
		915 062 004 000 Sleeve insert	6mm
07777	 4 057822 077778		
		915 062 006 000 Sleeve insert	8mm
07778	 4 057822 077785		
		915 062 008 000 Sleeve insert	10mm
07779	 4 057822 077792		
		915 062 009 000 Sleeve insert	12mm

KTK No.	RF No.	Bezeichnung Description Désignation	Erläuterungen Remarks Remarques
07780	 4 057822 077808		
		915 062 012 000 Sleeve insert	6mm
07765	 4 057822 077655		
		007 603 006 106 Copper washer	6x10x1 6mm
07764	 4 057822 077648		
		007 603 008 109 Copper washer	8x11.5x1 8mm
06511	 4 057822 065119		
		007 603 010 103 Copper washer	10x14x1.5 10mm
06512	 4 057822 065126		
		007 603 012 110 Copper washer	12x17x1.5 12mm

KTK No.	RF No.	Bezeichnung Description Désignation	Erläuterungen Remarks Remarques
---------	--------	---	---------------------------------------

06513



007 603 014 106 Copper washer

14x20x1.5  
14mm



06514

































007 603 016 103 Copper washer















16x22x1.5  
16mm







































KTK No.	RF No.	Bezeichnung Description Désignation	Erläuterungen Remarks Remarques
07285	 4 057822 072858		
  		Fitting automatic	4 mm Tube
07286	 4 057822 072865		
  		Fitting automatic	6 mm Tube
07287	 4 057822 072872		
  		Fitting automatic	8 mm Tube
07288	 4 057822 072889		
  		Fitting automatic	10 mm Tube
07289	 4 057822 072896		
  		Fitting automatic	12 mm Tube







KTK No.	RF No.	Bezeichnung Description Désignation	Erläuterungen Remarks Remarques
19161	 4 057822 191610		
  		Fitting automatic	16 mm Tube
07290	 4 057822 072902		
  		Fitting automatic	6 mm Tube
07291	 4 057822 072919		
  		Fitting automatic	8 mm Tube
07292	 4 057822 072926		
  		Fitting automatic	10 mm Tube
07293	 4 057822 072933		
  		Fitting automatic	12 mm Tube















KTK No.	RF No.	Bezeichnung Description Désignation	Erläuterungen Remarks Remarques
07294	 4 057822 072940	 <p>Fitting automatic</p>	<p>4 mm Tube</p> 
07295	 4 057822 072957	 <p>Fitting automatic</p>	<p>6 mm Tube</p> 
07296	 4 057822 072964	 <p>Fitting automatic</p>	<p>8 mm Tube</p> 
07297	 4 057822 072971	 <p>Fitting automatic</p>	<p>10 mm Tube</p> 
07298	 4 057822 072988	 <p>Fitting automatic</p>	<p>12 mm Tube</p> 

KTK No.	RF No.	Bezeichnung Description Désignation	Erläuterungen Remarks Remarques
07299	 4 057822 072995		
		Fitting automatic reducer	4x6 mm Tube
07300	 4 057822 073008		
		Fitting automatic reducer	6x8 mm Tube
07301	 4 057822 073015		
		Fitting automatic reducer	8x10 mm Tube
07302	 4 057822 073022		
		Fitting automatic reducer	10x12 mm Tube









KTK No.	RF No.	Bezeichnung Description Désignation	Erläuterungen Remarks Remarques
21776	 4 057822 217761	  Copper fitting	6mm
21777	 4 057822 217778	  Copper fitting	8mm
21778	 4 057822 217785	  Copper fitting	10mm
21779	 4 057822 217792	  Copper fitting	12mm
21780	 4 057822 217808	  Copper fitting	15mm

KTK No.	RF No.	Bezeichnung Description Désignation	Erläuterungen Remarks Remarques
21781	 4 057822 217818		
  		Copper fitting	16mm
21782	 4 057822 217825		
  		Copper fitting	1/4"
21783	 4 057822 217832		
  		Copper fitting	3/8"
21784	 4 057822 217849		
  		Copper fitting	1/2"

KTK No.	RF No.	Bezeichnung Description Désignation	Erläuterungen Remarks Remarques
08235	 4 057822 082352	  Hydraulic jack	20 TON
08218	 4 057822 082185	  Hydraulic jack	30 TON
08219	 4 057822 082192	  Hydraulic jack	50 TON

KTK No.	RF No.	Bezeichnung Description Désignation	Erläuterungen Remarks Remarques
08378	 4 057822 083786	 <p>5-core cable</p> 	<p>1 Roll 30met.</p>
08377	 4 057822 083779	 <p>7-core cable</p> 	<p>1 Roll 30met</p>
07157	 4 057822 071578	 <p>7-core cable 6C x 1.5sq + 1C x 2sq</p> 	<p>1 Roll 100met</p>
20897	 4 057822 208974	 <p>3 core cable</p> 	<p>100 Mtr Roll</p>
20898	 4 057822 208974	 <p>2 core cable</p> 	<p>100 Mtr Roll</p>



KTK No.	RF No.	Bezeichnung Description Désignation	Erläuterungen Remarks Remarques
07158	 4 057822 071581	  Battery cable Black Flexible copper	50 mm Sq. 1 Rolle 25met.
08375	 4 057822 083755	  50mm Battery Cable	Red
07159	 4 057822 071592	  70mm Battery cable Black Flexible copper	70 mm Sq. 1 Rolle 25met.
08376	 4 057822 083762	  70mm Battery Cable	Red